

Proximity sensors SMT/SME-8, for T-slot

FESTO



Festo core product range
Covers 80% of your automation tasks

Worldwide:

Always in stock

Superb:

Festo quality at an attractive price

Easy:

Reduces procurement and storing complexity

★ Ready for dispatch from the Festo factory in 24 hours
Held in stock in 13 service centres worldwide
More than 2200 products

★ Ready for dispatch in 5 days maximum from stock
Assembled for you in 4 service centres worldwide
Up to 6×10^{12} variants per product series

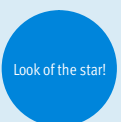

Proximity sensors SMT/SME

Product range overview

Design	Type of mounting	Measuring principle	Type	Operating voltage range	Switching output	Switching element function	→ Page/ Internet
For T-slot	Standard						
	Insertable in the slot from above, flush with the cylinder profile	Magneto-resistive	SMT-8M-A	5 ... 30 V DC	PNP	N/O contact	7
						N/C contact	
					NPN	N/O contact	
					Non-contacting, 2-wire	N/O contact	
	Insertable in the slot from above, flush with the cylinder profile	Magnetic reed	SME-8M	5 ... 30 V AC/DC	Contacting, bipolar	N/O contact	15
						N/C contact	
	Insertable in the slot lengthwise, flush with the cylinder profile	Magnetic reed	SME-8	12 ... 30 V AC/DC	Contacting, bipolar	N/O contact	31
				3 ... 230 V AC/DC		N/C contact	
	Insertable in the slot lengthwise	Magneto-resistive	SMT-8G	10 ... 30 V DC	PNP	N/O contact	38
			SMT-8-SL	10 ... 30 V DC	PNP	N/O contact	27
			SME-8-SL	10 ... 30 V AC/DC	Contacting, bipolar	N/O contact	31
	Insertable in the slot from above	Magnetic reed	SME-8-FM	10 ... 30 V AC/DC	Contacting, bipolar	N/O contact	44
	Via accessories	Magneto-resistive	SMT0-8E	10 ... 30 V DC	PNP	N/O contact	53
					NPN		
		Magnetic reed	SME0-8E	12 ... 30 V DC	Contacting, bipolar	N/O contact	58
				3 ... 250 V DC			
			3 ... 230 V AC				
	Corrosion-resistant						
	Insertable in the slot from above, flush with the cylinder profile	Magneto-resistive	CRSMT-8M	5 ... 30 V DC	PNP	N/O contact	23
	Insertable in the slot lengthwise, flush with the cylinder profile	Magneto-resistive	CRSMT-8	10 ... 30 V DC	PNP	N/O contact	27
	Welding field immune						
	Insertable in the slot from above, secured with screw	Magneto-resistive	SDBT-BSW	10 ... 30 V DC	PNP	N/O contact	47
					NPN		
					Non-contacting, 2-wire		
	Via accessories	Magneto-inductive	SMTSO-8E	10 ... 30 V DC	PNP	N/O contact	53
					NPN		
	Heat resistant up to 120 °C						
Insertable in the slot lengthwise, flush with the cylinder profile	Magnetic reed	SME-8-...-S6	0 ... 30 V AC/DC	Contacting, bipolar	N/O contact	35	
Via accessories	Magnetic reed	SME0-8E-...-S6	0 ... 30 V DC	Contacting	N/O contact	58	
			0 ... 30 V AC				
To EU Explosion Protection Directive (ATEX)							
Clamped in T-slot	Magneto-inductive	SMT-8F-I ...	8.2 V DC	NAMUR	NAMUR	41	

Proximity sensors SMT/SME

Product range overview

Design	Type of mounting	Measuring principle	Type	Operating voltage range	Switching output	Switching element function	→ Page/ Internet
For C-slot	Standard	Magneto-resistive	SMT-10M	10 ... 30 V DC	PNP	N/O contact	C-slot
					NPN		
					Non-contacting, 2-wire		
	Insertable in the slot from above, flush with the cylinder profile	Magnetic reed	SME-10M	5 ... 30 V AC/DC	Contacting, bipolar	N/O contact	
		Magneto-resistive	SMT-10G	10 ... 30 V DC	PNP	N/O contact	
			SME-10	12 ... 27 V AC/DC	Contacting	N/O contact	

T-slot sensors can be used for drives with T-slot

Exceptions

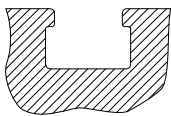

- DFM-B: SMT0-8E, SMTSO-8E, SME0-8E, SMP0-8E cannot be used
- DHDS: SME-8M can only be used on $\varnothing 50$
- DHPS: SME-8M can only be used on $\varnothing 20 \dots 35$
- HGDD-63-A: SMT-8M-A cannot be used
- HGPT-B: SMT-8G can only be used from size 40 upwards
- SDBT-BSW- ... -PU/NU can only be used on a limited number of drive series. Page → 47

C-slot sensors can be used for drives with C-slot

Exceptions

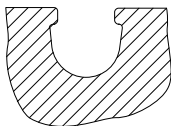

- ADVC $\varnothing 100$: SMT-10M and SME-10M cannot be used (ADVC has a T-slot and C-slot)
- DSM/DSM-B-6/8/10: SME-10M cannot be used
- DSM/DSM-B-10/16: SMT-10M cannot be used
- HGPT-B: SMT-10G can only be used up to size 35

For drives with sensor rail: these are available with 2 cylinder barrel contours

Only T-slot sensors CRSMT-8M and SMT-8M-A can be used, and only with the profile identified below as being suitable

Example: DSBF

Example: CDC

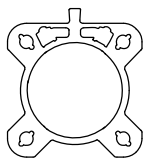

Suitable

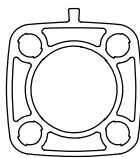

Not suitable

Proximity sensors SMT/SME-8, for T-slot

Peripherals overview

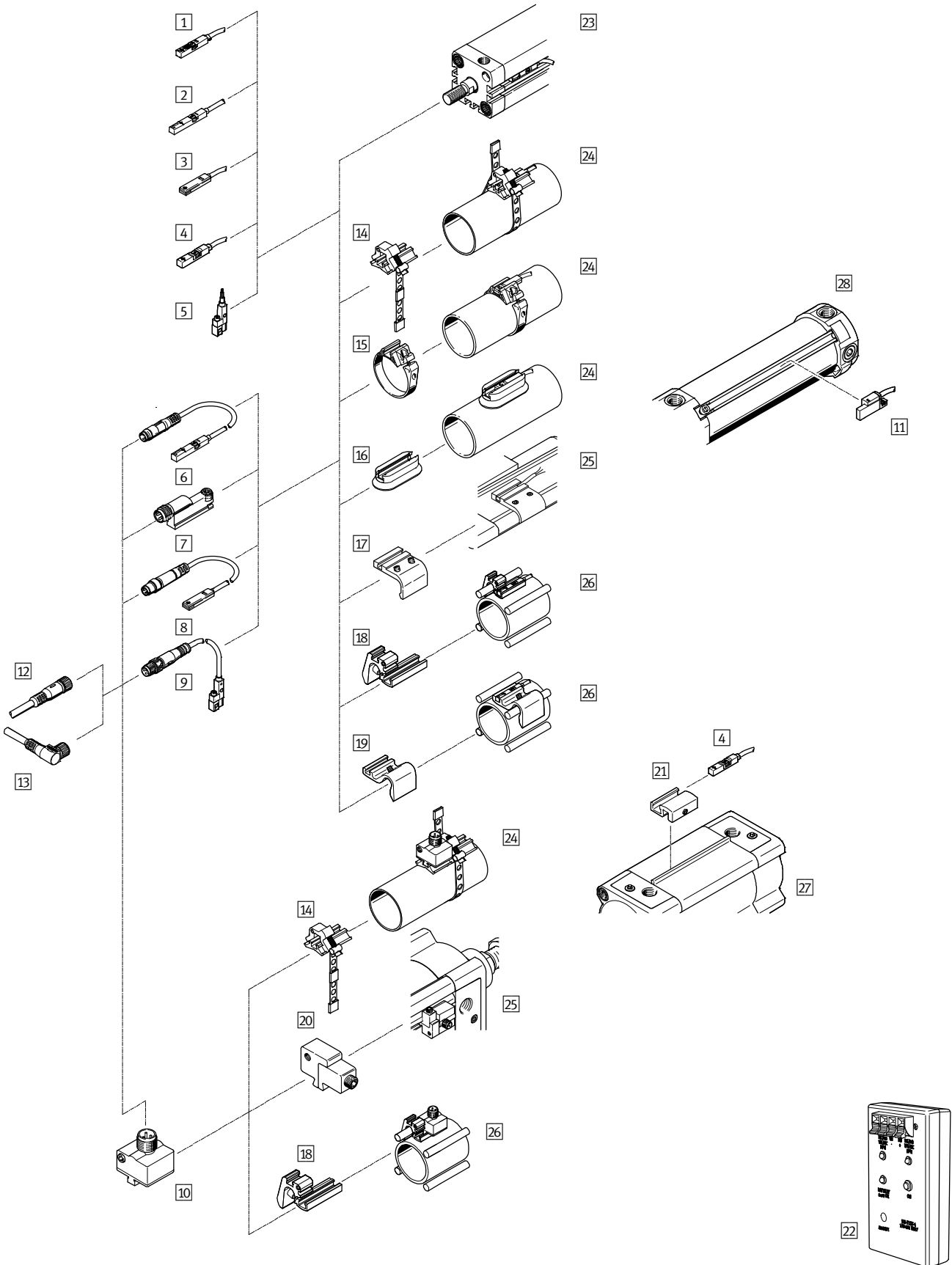

Proximity sensors SMT/SME-8, for T-slot

Peripherals overview

FESTO

Mounting components and accessories		→ Page/ Internet
Proximity sensor		
1	SMT-8M-A-..., with cable	7
2	SME-8M-...-OE, with cable	15
3	SME-8-FM-...-K-..., with cable	44
	CRSMT-8-K-..., with cable, corrosion-resistant	27
4	CRSMT-8M-..., with cable	23
5	SMT-8G-...-OE, with cable	39
6	SME-8M-...-M..., with cable and plug connector	15
7	SMT-8-SL-..., with plug connector	27
	SME-8-SL-..., with plug connector	31
8	SME-8-S-..., with cable and plug connector	31
9	SMT-8G-...-M..., with cable and plug connector	39
10	SMT0/SMTSO, with plug connector	53
	SME0-8E, with cable or plug connector	58
11	SDBT-BSW, welding field immune	47
Connecting cables		
12	NEBU-M...G...	66
13	NEBU-M...W...	66

Mounting components and accessories		→ Page/ Internet
Mounting kits and accessories		
14	Mounting kit SMBR-8-8/100-S6, heat-resistant	62
15	Mounting kit SMBR	62
16	Mounting kit CRSMB, corrosion-resistant	63
17	Mounting kit SMB-8-FENG	63
18	Mounting SMBZ-8-...	65
19	Sensor bracket DASP-M4-...	64
20	Mounting kit SMB-8E	63
21	Mounting kit SMB-8-C	64
22	Sensor tester SM-TEST-1	66
-	Position marker SMM-8	65
-	Clip SMBK-8	66
-	Inscription label ASLR	66
-	Safety clip NEAU	66
Drives		
23	Drives with T-slot	-
24	Round cylinders	-
25	Standard cylinders DSBC	-
26	Drives with tie or mounting rod	-
27	Standard cylinders DSBF	-
28	Hinge cylinders DFAW	-

Proximity sensors SMT-8M-A, for T-slot

Type codes



SMT-8M-A

SMT-8M - A - PO - 24V - E - 0,5 - N - OE -

Function

SMT-8M	Proximity sensor, magneto-resistive, for T-slot, insertable in the slot from above
--------	--

Series

A	Short design
---	--------------

Switching output

PS	PNP, N/O contact, 3-wire
PO	PNP, N/C contact, 3-wire
NS	NPN, N/O contact, 3-wire
ZS	N/O contact, 2-wire
PNS	PNP, NPN switchable
PSO	PNP, N/C contact, N/O contact switchable

Rated operating voltage

24V	24 V DC
-----	---------

Cable characteristics

E	Energy chain + robot
---	----------------------

Cable length [m]

Cable designation

-	With inscription label holder
N	Without inscription label holder

Electrical connection

OE	Open end
M8	Cable with plug M8x1, snap-on flange
M8D	Cable with plug M8x1, rotatable thread
M12	Cable with plug M12x1, rotatable thread

EU certification

Ex2	II 3GD in accordance with EU Directive 2014/34/EU
-----	---

Proximity sensors SMT-8M-A, for T-slot

Technical data – Magneto-resistive

Function

e.g. PNP, N/O contact, with cable

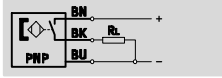

e.g. NPN, N/O contact, with cable

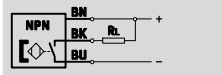

- Magneto-resistive measuring principle
- Insertable in the slot from above, does not protrude over the cylinder profile
- Cable clip and inscription labels included in the scope of delivery
- Variant EX2 for use in potentially explosive areas in zones 2 and 22



General technical data	
Design	For T-slot
Assembly position	Any
Based on standard	EN 60947-5-2
Approval certificate	c UL us - Listed (OL) RCM trademark
CE marking (see declaration of conformity)	To EU EMC Directive
Note on materials	Cable halogen-free, oil-resistant RoHS-compliant, free of copper and PTFE

Input signal/measuring element	
Measured variable	Position
Measuring principle	Magneto-resistive
Ambient temperature	[°C] -40 ... +85

Switching output						
Type	PS	NS	PO	ZS	PNS	PSO
Switching output	PNP	NPN	PNP	Non-contacting, 2-wire	PNP, NPN switchable	PNP
Switching element function	N/O contact	N/O contact	N/C contact	N/O contact	N/O contact	N/C contact, N/O contact switchable
Repetition accuracy	[mm]	±0.1				
Switch-on time	[ms]	≤ 1.3			≤ 1.0	
Switch-off time	[ms]	≤ 1.4			≤ 1.0	
Max. output current	[mA]	100 ¹⁾	100 ¹⁾	100 ¹⁾	80 ¹⁾	100
Max. output current in mounting kits	[mA]	100			80 ¹⁾	100
Max. switching capacity DC	[W]	2.8	2.8	2.8	1.9	2.7
Max. switching capacity DC in mounting kits	[W]	2.8 ²⁾	2.8 ²⁾	2.8 ²⁾	1.5 ²⁾	2.7
Max. switching frequency	[Hz]	180				
Voltage drop ¹⁾	[V]	< 1.5			< 6	< 2.5

1) Variant ...PS/NS/PO...-Ex2: max. output current in mounting kits 80 mA, T_a 70 °C
Variant ...ZS...-Ex2: max. output current in mounting kits 50 mA, T_a 70 °C
2) Variant ...PS/NS/PO...-Ex2: max. switching capacity 2.2 W
Variant ...ZS...-Ex2: max. switching capacity 1.2 W

Output, additional data	
Protection against short circuit	Pulsed
Overload protection	Yes

Proximity sensors SMT-8M-A, for T-slot

FESTO

Technical data – Magneto-resistive

Electronic components				
Type		PS, NS, PO, ZS	PNS, PSO	Ex2
Operating voltage range	[V DC]	5 ... 30	7 ... 30	5 ... 30
Rated operating voltage	[V DC]	24		
Reverse polarity protection		For all electrical connections		

Electromechanical components					
Electrical connection		M8	M8D	M12	OE
Electrical connection		Cable with plug, 3-pin			Cable, 3-wire
		M8x1		M12x1	Cable, 2-wire
		–	Rotatable thread		
Connection direction		In-line			
Cable test conditions		Energy chain: 5 million cycles, bending radius 28 mm			
		Torsional strength: > 300,000 cycles, ±270°/0.1 m			
		Resistance to bending: according to Festo standard; test conditions on request			
Cable length	[m]	0.1 ... 30			
Cable characteristics		Energy chain + robot			
Cable sheath materials		TPE-U(PUR)			
Cable sheath colour		Grey			

Mechanical components				
Electrical connection		M8, M8D, M12		OE
Type of mounting		Screw-clamped, insertable in the slot from above		
Max. tightening torque	[Nm]	0.6		
Housing		Black		
		PA reinforced		
		High-alloy stainless steel		
		Nickel-plated brass		–

Proximity sensors SMT-8M-A, for T-slot

Technical data – Magneto-resistive

Display/operation			
	PS, NS, PO, ZS	PNS	PSO
Switching status indication	Yellow LED	Yellow LED (for PNP)/white LED (for NPN)	Yellow LED (for N/O contact)/white LED (for N/C contact)
Operating reserve indication	Orange LED	-	

Immissions/emissions	
Ambient temperature with flexible cable installation [°C]	-20 ... +85
Degree of protection	IP65, IP68, IP69K

ATEX	
SMT-8M-A-...-	Ex2
ATEX category for gas	II 3G
Explosion ignition protection type for gas	Ex nA IIC T4 X Gc
ATEX category for dust	II 3D
Explosion ignition protection type for dust	Ex tc IIIC T120 °C X Dc
Explosion-proof temperature	-40 °C ≤ Ta ≤ +70 °C
Explosion protection	Zone 2 (ATEX) Zone 22 (ATEX)
CE marking (see declaration of conformity)	To EU Explosion Protection Directive (ATEX)

Pin allocation to EN 60947-5-2			
M8x1, 2-pin		M12x1, 2-pin	
N/O contact		N/O contact	
	Pin	Wire colour	Allocation
	1	Brown	+
	4	Black	-
	1	Brown	+
	4	Black	-

Pin allocation to EN 60947-5-2			
M8x1, 3-pin		M12x1, 3-pin	
N/O contact and N/C contact		N/O contact	
	Pin	Wire colour	Allocation
	1	Brown	+
	3	Blue	-
	4	Black	Output
	1	Brown	+
	3	Blue	-
	4	Black	Output

Pin allocation to EN 60947-5-2			
M12x1, 3-pin		N/C contact	
	Pin	Wire colour	Allocation
	1	Brown	+
	3	Blue	-
	2	White	Output

Proximity sensors SMT-8M-A, for T-slot

Technical data – Magneto-resistive



Dimensions

Download CAD data → www.festo.com

SMT-8M-A-24V-E-...-... (PS, NS, PO, ZS)

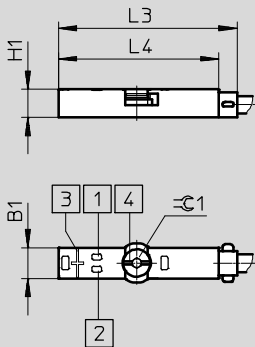

Yellow LED for safe switching status.
Yellow and orange LED for unsafe switching status.

- 1 Yellow LED
- 2 Orange LED
- 3 Position of sensor element centre
- 4 Tightening torque of clamping component 0.6 Nm

SMT-8M-A-24V-E-...-... (PNS, PSO)

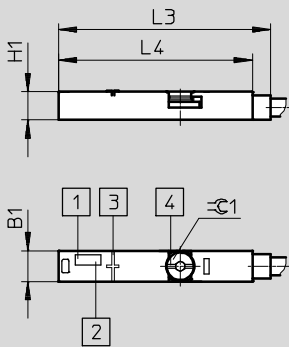

Switching status indication for PNS:
Yellow LED for PS switching output.
White LED for NS switching output.

- 1 Yellow LED
- 2 White LED
- 3 Position of sensor element centre
- 4 Slot for screwdriver

Switching status indication for PSO:
Yellow LED for PS switching output.
White LED for PO switching output.

Type	B1	H1	L3	L4	± 0.1
SMT-8M-A-...-24V-E- (PS, NS, PO, ZS)	5	4.6	29.3	26.3	1.5
SMT-8M-A-...-24V-E- (PNS, PSO)			34.8	31.8	

Proximity sensors SMT-8M-A, for T-slot

Technical data – Magneto-resistive

Dimensions

Download CAD data → www.festo.com

SMT-8M-A-...-OE/OE-Ex – Cable

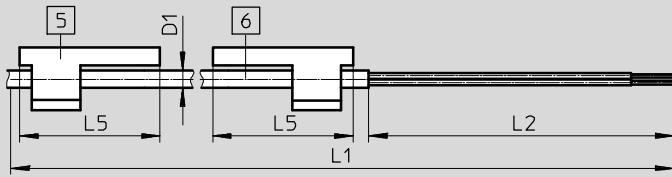

- 5 Inscription label holder drawn turned by 90°
- 6 Connecting cable
- L1 Cable length

SMT-8M-A-...-M8D – Cable with plug M8x1, rotatable thread

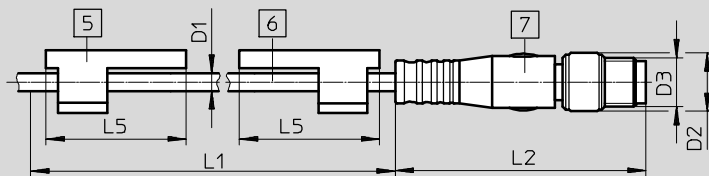

- 5 Inscription label holder drawn turned by 90°
- 6 Connecting cable
- 7 Plug suitable for connecting cable NEBU-M8
- L1 Cable length

SMT-8M-A-...-M8 – Cable with plug M8x1, snap-on flange

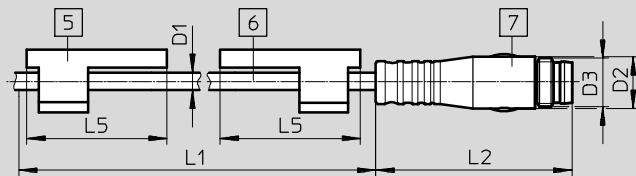

- 5 Inscription label holder drawn turned by 90°
- 6 Connecting cable
- 7 Plug suitable for connecting cable NEBU-M8
- L1 Cable length

SMT-8M-A-...-M12 – Cable with plug M12x1, rotatable thread

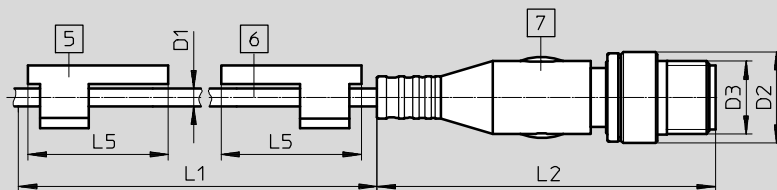

- 5 Inscription label holder drawn turned by 90°
- 6 Connecting cable
- 7 Plug suitable for connecting cable NEBU-M12
- L1 Cable length

Type	D1	D2 Ø	D3	L2	L5	± 1
SMT-8M-A-...-OE	2.9	-	-	50	23	1.5
SMT-8M-A-...-OE-Ex		-	-	50		
SMT-8M-A-...-M8D		9.6	M8x1	41.1		
SMT-8M-A-...-M8		8.5	M8x1	32.7		
SMT-8M-A-...-M12		15	M12x1	54.5		

Proximity sensors SMT-8M-A, for T-slot

Technical data – Magneto-resistive

FESTO

★ Core product range

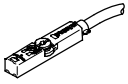
Ordering data								
	Switching output	Electrical connection			Cable length [m]	Weight [g]	Part No.	Type
		Cable	Cable with plug, rotatable thread					
			M8x1	M12x1				
	N/O contact							
	PNP	–	3-pin	–	0.3	8.9	★ 574334	SMT-8M-A-PS-24V-E-0,3-M8D
	PNP	3-wire	–	–	2.5	29.1	★ 574335	SMT-8M-A-PS-24V-E-2,5-OE
	PNP	3-wire	–	–	5	57.1	★ 574336	SMT-8M-A-PS-24V-E-5,0-OE
	PNP	–	–	3-pin	0.3	15.9	★ 574337	SMT-8M-A-PS-24V-E-0,3-M12
	NPN	3-wire	–	–	2.5	29.1	★ 574338	SMT-8M-A-NS-24V-E-2,5-OE
			–	3-pin	–	0.3	8.9	★ 574339
	Non-contacting	2-wire	–	–	5	57.1	★ 574341	SMT-8M-A-ZS-24V-E-5,0-OE-Ex2
N/C contact								
PNP	3-wire	–	–	7.5	85.1	★ 574340	SMT-8M-A-PO-24V-E-7,5-OE	

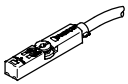
Ordering data								
	Switching output	Electrical connection			Cable length [m]	Weight [g]	Part No.	Type
		Cable	Cable with plug, rotatable thread					
			M8x1	M12x1				
	N/O contact							
	PNP	–	3-pin	–	0.3	8.9	574342	SMT-8M-A-PS-24V-E-0,3-M8D-Ex2
	Switchable							
	PNP/NPN	–	3-pin	–	0.3	9	574343	SMT-8M-A-PNS-24V-E-0,3-M8D
PNP PS/PO	–	3-pin	–	0.3	9	574344	SMT-8M-A-PSO-24V-E-0,3-M8D	

Festo core product range

★ Ready for dispatch from the Festo factory in 24 hours

☆ Ready for dispatch in 5 days maximum from stock

Proximity sensors SMT-8M-A, for T-slot

Ordering data – Modular products

Ordering table				
Size	8	Condi- tions	Code	Entry code
M Module No.	574333			
Function	Proximity sensor for T-slot, electronic		SMT-8M	SMT-8M
			-	-
Series	Short design		A	A
			-	-
Switching output	3-wire PNP N/O contact		PS	
	3-wire NPN N/O contact		NS	
	3-wire PNP N/C contact		PO	
	2-wire N/O contact		ZS	
	PNP/NPN switchable		PNS	
	PNP N/C contact, N/O contact switchable		PSO	
			-	-
Rated operating voltage [V DC]	24		24V	24V
			-	-
Cable characteristics	Energy chain + robot		E	E
			-	-
Cable length [m]	0.1 ... 30 (0.1 ... 5.0 in 0.1 increments, 5.0 ... 30 in 0.5 increments)		...	
			-	-
Cable designation	With inscription label holder			
	Without inscription label holder		N	
			-	-
Connection technology	Open end		OE	
	M8, rotatable thread		M8D	
	M8, snap-on flange		M8	
	M12, rotatable thread		M12	
			-	-
O EU certification	II 3GD in accordance with EU Directive 2014/34/EU	1	-Ex2	

1 Ex2 Not with switching output PNS, PSO, minimum cable length 0.2 m

Transfer order code

574333 SMT-8M - A - [] - 24V - E - [] - N - [] - []

Proximity sensors SME-8M, for T-slot

Type codes

SME-8M

SME - 8M - DO - 24V - K - 7,5 - OE

Function	
SME	Proximity sensor, magneto-resistive

Design	
8M	For T-slot, insertable in the slot from above

Switching output, switching element function	
ZS	N/O contact, 2-wire
DS	N/O contact, 3-wire
DO	N/C contact, 3-wire

Rated operating voltage	
24V	24 V DC

Cable characteristics	
K	Standard + energy chain
E	Energy chain + robot

Cable length [m]	
...	0.2 ... 10

Electrical connection	
OE	Open end
M8	Cable with plug M8x1, snap-on flange
M8D	Cable with plug M8x1, rotatable thread
M12	Cable with plug M12x1, rotatable thread

Proximity sensors SME-8M, for T-slot

Technical data – Magnetic reed

Function

e.g. N/O contact, 3-wire, with cable

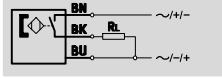

e.g. N/O contact, 3-wire, with plug

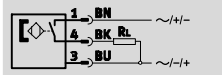

- Magnetic reed measuring principle
- Insertable in the slot from above, does not protrude over the cylinder profile
- Cable clip and inscription labels included in the scope of delivery

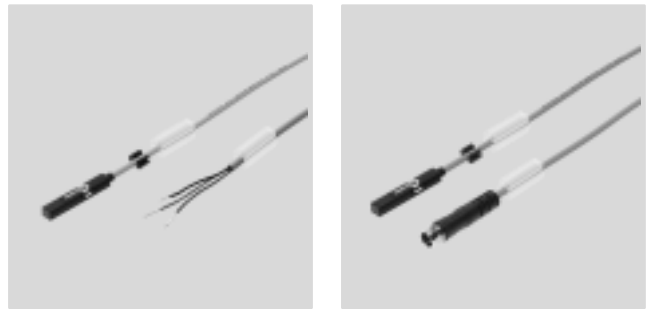

General technical data	
Design	For T-slot
Based on standard	EN 60947-5-2
Approval certificate	c UL us - listed (OL) RCM trademark
CE marking (see declaration of conformity)	To EU EMC Directive
Special characteristics	Oil resistant
Note on materials	Free of copper and PTFE RoHS-compliant

Input signal/measuring element	
Measuring principle	Magnetic reed
Ambient temperature	[°C] -40 ... +70

Switching output			
Type	SME-8M-DS	SME-8M-ZS	SME-8M-DO
Switching output	Contacting, bipolar		
Switching element function	N/O contact	N/O contact	N/C contact
Max. output current [mA]	500	80	
Max. output current in mounting kits [mA]	80	80	
Max. switching capacity DC [W]	10	2.4	
Max. switching capacity DC in mounting kits [W]	2.4	2.4	
Max. switching capacity AC [VA]	10	2.4	
Max. switching capacity AC in mounting kits [VA]	2.4	2.4	
Voltage drop ¹⁾ [V]	≤1.5	≤4.8	≤3.5

1) Applies to cable length 2.5m. Max. 0.15V voltage drop per metre of additional cable length

Output, additional data	
Protection against short circuit	No
Overload protection	No

Electronic components	
Operating voltage range DC [V]	5 ... 30
Operating voltage range AC [V]	5 ... 30
Reverse polarity protection	No

Proximity sensors SME-8M, for T-slot

Technical data – Magnetic reed

Electromechanical components								
Switching element function	DS/DO				ZS			
Electrical connection	OE	M8D	M8	M12	OE	M8D	M8	M12
Electrical connection	Cable, 3-wire	Cable with plug, 3-pin			Cable, 2-wire	Cable with plug, 2-pin		
		M8x1	M8x1	M12x1		M8x1	M8x1	M12x1
		Rotatable thread	Snap-on flange	Rotatable thread		Rotatable thread	Snap-on flange	Rotatable thread
Connection direction	In-line							
Cable test conditions	K	Energy chain: 5 million cycles, bending radius 75 mm						
		Resistance to bending: to Festo standard; test conditions on request						
	E	Energy chain: 5 million cycles, bending radius 28 mm						
		Torsional strength: $\pm 270^\circ/0.1$ m						
		Resistance to bending: to Festo standard; test conditions on request						
Cable length	[m]	0.2 ... 10						
Cable characteristics	K	Standard + energy chain						
	E	Energy chain + robot						
Cable sheath materials	K	TPE-U(PUR)						
	E	TPE-U(PUR), halogen-free						

Mechanical components		
Electrical connection	OE	M...
Type of mounting	Screw-clamped, insertable in the slot from above	
Housing	PA	PA
	High-alloy stainless steel	High-alloy stainless steel
	–	Nickel-plated brass
	–	TPE-U(PUR)

Display/operation	
Switching status indication	Yellow LED

Immissions/emissions	
Ambient temperature with flexible cable installation	[°C] –5 ... +70
Degree of protection	IP65, IP68

Proximity sensors SME-8M, for T-slot

Technical data – Magnetic reed

Pin allocation to EN 60947-5-2			
M8x1, 2-pin			
N/O contact			
	Pin	Wire colour	Allocation
	1	Brown	+
	4	Black	Output
M12x1, 2-pin			
N/O contact			
	Pin	Wire colour	Allocation
	1	Brown	+
	4	Black	Output

Pin allocation to EN 60947-5-2			
M8x1, 3-pin			
N/O contact and N/C contact			
	Pin	Wire colour	Allocation
	1	Brown	+
	3	Blue	-
	4	Black	Output
M12x1, 3-pin			
N/O contact			
	Pin	Wire colour	Allocation
	1	Brown	+
	3	Blue	-
	4	Black	Output

Pin allocation to EN 60947-5-2			
M12x1, 3-pin			
N/C contact			
	Pin	Wire colour	Allocation
	1	Brown	+
	3	Blue	-
	2	White	Output

Proximity sensors SME-8M, for T-slot

Technical data – Magnetic reed



Dimensions

Download CAD data → www.festo.com

SME-8M-...-OE – Cable

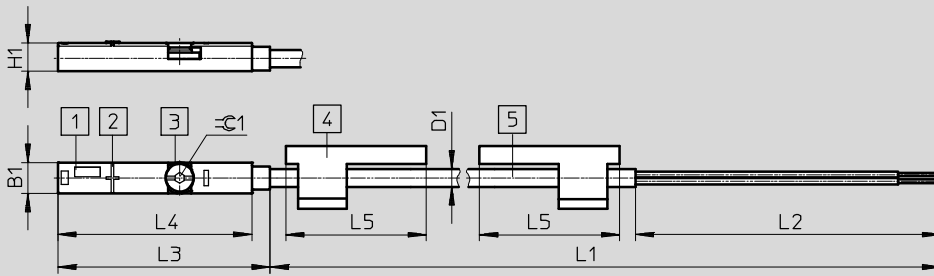

- 1 Yellow LED
- 2 Centre of the sensor element
- 3 Clamping component, tightening torque 0.6 Nm
- 4 Inscription label holder
- 5 Connecting cable

L1 Cable length

SME-8M-DO-...-OE – Cable

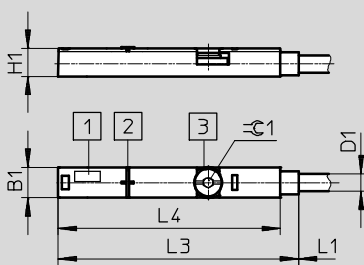

- 1 Light-emitting diode (LED)
- 2 Centre of the sensor element
- 3 Clamping component, tightening torque 0.6 Nm

L1 Cable length

SME-8M-...-M8D – Cable with plug M8x1, rotatable thread

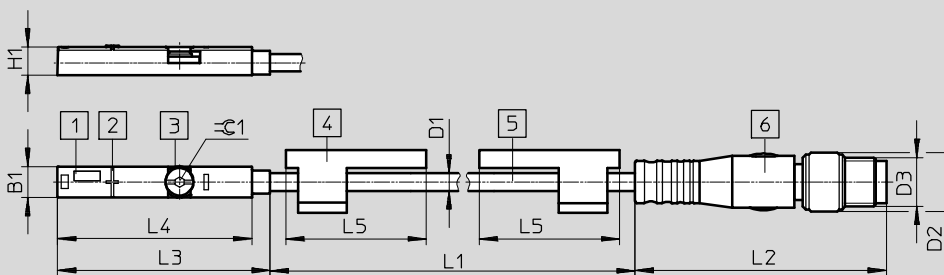

- 1 Yellow LED
- 2 Centre of the sensor element
- 3 Clamping component, tightening torque 0.6 Nm
- 4 Inscription label holder
- 5 Connecting cable
- 6 Plug to fit connecting cable NEBU-M8

L1 Cable length

SME-8M-...-M8 – Cable with plug M8x1, snap-on flange

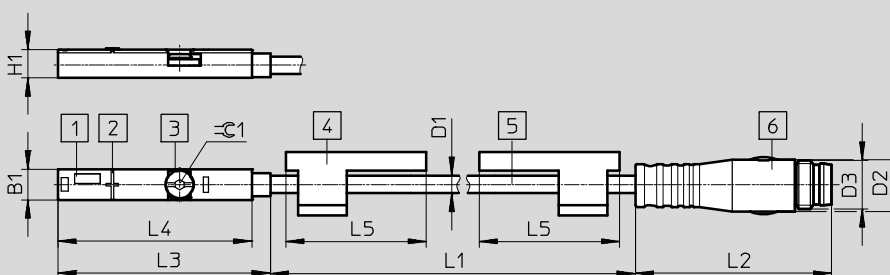

- 1 Yellow LED
- 2 Centre of the sensor element
- 3 Clamping component, tightening torque 0.6 Nm
- 4 Inscription label holder
- 5 Connecting cable
- 6 Plug to fit connecting cable NEBU-M8

L1 Cable length

Type	B1 ±0.05	D1 ∅	D2 ∅	D3	H1 ±0.05	L2	L3	L4 ±0.1	L5	⌀ 1
SME-8M-...-OE	5	2.9	-	-	4.6	50	34.8	31.8	23	1.5
SME-8M-DO-...-OE			-	-		-	39.5	36.5	-	
SME-8M-...-M8D			9.6	M8x1		41	34.8	31.8	23	
SME-8M-...-M8			8.5	M8x1		33	34.8	31.8	23	

Proximity sensors SME-8M, for T-slot

Technical data – Magnetic reed

Dimensions

Download CAD data → www.festo.com

SME-8M-...-M12 – Cable with plug M12x1, rotatable thread

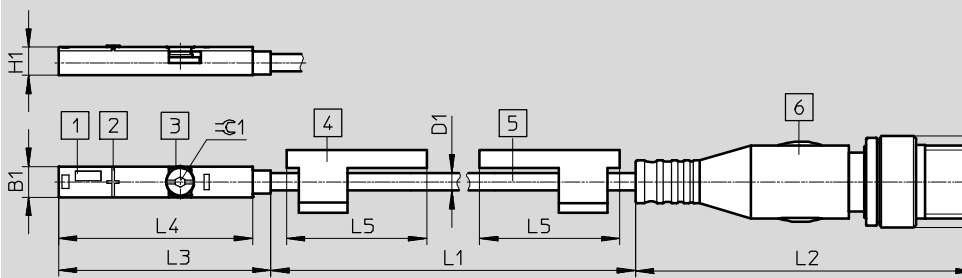

- 1 Yellow LED
 - 2 Centre of the sensor element
 - 3 Clamping component, tightening torque 0.6 Nm
 - 4 Inscription label holder
 - 5 Connecting cable
 - 6 Plug to fit connecting cable NEBU-M12
- L1 Cable length

Type	B1	D1 ∅	D2	D3	H1	L2	L3	L4	L5	⊕ 1
SME-8M-...-M12	5	2.9	15	M12x1	4.6	54.5	34.8	31.8	23	1.5

★ Core product range

Ordering data

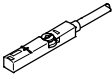
	Switching output	Electrical connection		Cable length [m]	Part No.	Type
		Cable	Cable with plug, rotatable thread, M8x1			
	N/O contact					
	Contacting, bipolar	3-wire	–	2.5	★ 543862	SME-8M-DS-24V-K-2,5-OE
		–	3-pin	0.3	★ 543861	SME-8M-DS-24V-K-0,3-M8D
		2-wire	–	2.5	★ 543872	SME-8M-ZS-24V-K-2,5-OE
N/C contact						
	Contacting, bipolar	3-wire	–	7.5	★ 546799	SME-8M-DO-24V-K-7,5-OE

Ordering data

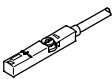
	Switching output	Electrical connection		Cable length [m]	Part No.	Type
		Cable	Cable with plug, rotatable thread, M8x1			
	N/O contact					
	Contacting, bipolar	3-wire	–	7.5	543876	SME-8M-DS-24V-K-7,5-OE

Festo core product range

- ★ Ready for dispatch from the Festo factory in 24 hours
- ☆ Ready for dispatch in 5 days maximum from stock

Proximity sensors SME-8M, for T-slot

Modular products – Magnetic reed



M Mandatory data

Module No.	Function	Switching output	Rated operating voltage	Cable characteristics	Cable length	Connection technology
543892	SME-8M	DS ZS DO	24V	K E	0.2 ... 10	OE M8D M8 M12
Ordering example						
543892	SME-8M	ZS	24V	K	0.8	OE

Ordering table

Size	8	Condi-tions	Code	Entry code
M Module No.	543892			
Function	Proximity sensor for T-slot, contacting		SME-8M	SME-8M
Switching output	3-wire N/O contact		DS	–
	2-wire N/O contact		ZS	–
	3-wire N/C contact		DO	–
Rated operating voltage [V DC]	24		24V	24V
			–	–
			–	–
Cable characteristics	Standard + energy chain		K	–
	Energy chain + robot		E	–
Cable length [m]	0.2 ... 10		...	–
	(0.2 ... 5.0 m in 0.1 m increments, 5.0 ... 10 m in 0.5 m increments)		–	–
Connection technology	Open end		OE	–
	M8, rotatable thread		M8D	–
	M8, snap-on flange		M8	–
	M12, rotatable thread		M12	–

Transfer order code

543892	SME-8M	–		–	24 V	–		–		–	
--------	--------	---	--	---	------	---	--	---	--	---	--

Proximity sensors CRSMT-8/SMT-8-SL/SME-8, for T-slot

Type codes

CRSMT-8

CRSMT – 8 – PS – K2,5 – LED – 24

Function

CRSMT	Proximity sensor, magneto-resistive, suitable for the food industry, resistant to acids and cooling lubricants
-------	--

Design

8	For T-slot, insertable in the slot lengthwise
---	---

Switching output, switching element function

PS	PNP, N/O contact, 3-wire
----	--------------------------

Electrical connection, cable length

K2,5	Cable, 2.5 m
K5	Cable, 5.0 m

Switching status indication

LED	Yellow LED
-----	------------

Rated operating voltage

24	24 V DC
----	---------

CRSMT-8M

CRSMT – 8M – PS – 24 – K – – –

Function

CRSMT	Proximity sensor, magneto-resistive, suitable for the food industry, resistant to acids and cooling lubricants
-------	--

Design

8M	For T-slot, insertable in the slot from above
----	---

Switching output, switching element function

PS	PNP, N/O contact, 3-wire
----	--------------------------

Rated operating voltage

24	24 V DC
----	---------

Cable attribute

K	Standard and chain link trunking
---	----------------------------------

Cable length

0.3	Cable, 0.3m ¹⁾
K5	Cable, 5 m, open end ²⁾
K10	Cable, 10 m, open end ²⁾

Connection

OE	Open end
M8D	M8, rotatable thread
M12	M12

1) Only with M8D or M12 connection

2) Only with OE connection

Proximity sensors CRSMT-8/SMT-8-SL/SME-8, for T-slot

Type codes

SMT/SME-8

SMT – 8 – PS – K – LED – 24 – B

Function	
SMT	Proximity sensor, magneto-resistive
SME	Proximity sensor, magnetic reed

Design	
8	For T-slot, insertable in the slot lengthwise

Switching output, switching element function	
PS	PNP, N/O contact, 3-wire
NS	NPN, N/O contact, 3-wire
ZS	N/O contact, 2-wire
O	N/C contact, 3-wire

Electrical connection, cable length	
K	Cable, 2.5 m or 7.5 m
K2.5	Cable, 2.5 m
K5	Cable, 5.0 m
K-7,5	Cable, 7.5 m
KL	Cable, 2.5 m
S	Plug M8x1 with cable, 0.3 m

Switching status indication	
LED	Yellow LED

Rated operating voltage	
24	24 V DC
230	230 V AC

Variant	
K6	Heat resistant

Generation	
B	B series

SMT/SME-8-SL

SMT – 8 – SL – PS – LED – 24

Function	
SMT	Proximity sensor, magneto-resistive
SME	Proximity sensor, magnetic reed

Design	
8	For T-slot, insertable in the slot lengthwise

Electrical connection	
SL	Plug

Switching output, switching element function	
PS	PNP, N/O contact, 3-wire

Switching status indication	
LED	Yellow LED

Rated operating voltage	
24	24 V DC

Proximity sensors CRSMT-8M, for T-slot

Technical data – Magneto-resistive

Function

e.g. PNP, N/O contact, with plug

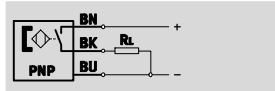
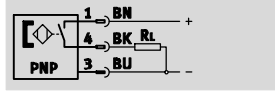

- Suitable for foodstuffs
- Acid resistant
- Alkali resistant
- Resistant to cooling lubricants



General technical data	
Design	For T-slot
Based on standard	EN 60947-5-2
Approval certificate	RCM trademark
Special characteristics	Acid resistant, alkali resistant, resistant to cooling lubricants
Suitable for use in the food industry ¹⁾	As per manufacturer's declaration
Note on materials	RoHS-compliant, halogen-free

1) Additional information www.festo.com/sp → Certificates.

Input signal/measuring element	
Measuring principle	Magneto-resistive
Measured variable	Position
Ambient temperature	[°C] -40 ... 85

Switching output	
Switching element function	N/O contact
Switching output	PNP
Switching output repetition accuracy	[mm] ± 0.1
Switch-on time	[ms] ≤ 1
Switch-off time	[ms] ≤ 1
Max. switching frequency	[Hz] 180
Max. output current	[mA] 100
Max. switching capacity DC	[W] 2.8
Voltage drop	[V] < 1.5
Residual current	[mA] < 0.05

Output, additional data	
Protection against short circuit	Pulsed
Overload protection	Yes

Electronic components	
Switching output	PNP
Rated operating voltage	[V DC] 24
Operating voltage range	[V DC] 5 ... 30
Reverse polarity protection	For all electrical connections

Proximity sensors CRSMT-8M, for T-slot

Technical data – Magneto-resistive

FESTO

Electromechanical components	
Connection direction	In-line
Cable characteristics	Standard + energy chain
Cable test conditions	Energy chain: 5 million cycles, bending radius 75 mm
	Torsional strength: > 300,000 cycles, $\pm 270^\circ/0.1$ m
	Bending strength: according to Festo standard

Mechanical components			
Electrical connection	Cable, 3-wire	Cable with plug, rotatable thread M8D M12	
Type of mounting	Screw-clamped Insertable in the slot from above		
Assembly position	Any		
Max. tightening torque [Nm]	0.6		
	–	0.3	0.5
Information on materials			
Housing	High-alloy stainless steel, PP		
Union nut	–	Nickel-plated brass	
Cable sheath	TPE-O		
Insulating sheath	PP		
Plug housing	–	PP	
Wire ends	Wire end sleeves	–	
Pin contacts	–	Nickel-plated and gold-plated brass	

Display/operation	
Switching status indication	Yellow LED
Operating reserve indication	Orange LED

Immissions/emissions	
Ambient temperature with flexible cable installation [°C]	–20 ... 85
Degree of protection	IP65
	IP68
	IP69K

ATEX	
ATEX category for gas	II 3G
Explosion ignition protection type for gas	Ex nA IIC T4 X Gc
ATEX category for dust	II 3D
Explosion ignition protection type for dust	Ex tc IIIC T120°C X Dc
Explosion-proof temperature [°C]	–40°C \leq Ta \leq +85°C
CE marking (see declaration of conformity)	To EU EMC Directive
	To EU Explosion Protection Directive (ATEX)

Proximity sensors CRSMT-8M, for T-slot

Technical data – Magneto-resistive

Pin allocation to EN 60947-5-2				M12x1, 3-pin			
M8x1, 3-pin				N/O contact			
	Pin	Wire colour	Allocation		Pin	Wire colour	Allocation
	1	Brown	+		1	Brown	+
	3	Blue	-		3	Blue	-
	4	Black	Output		4	Black	Output

Dimensions, open end

Download CAD data → www.festo.com

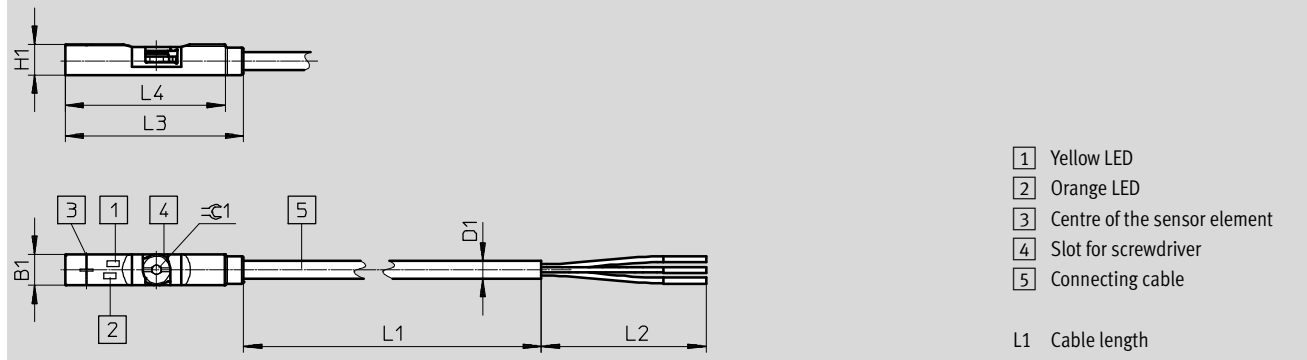

Type	B1	D1	H1	L2	L3	L4	⌀ 1
CRSMT-8M-PS-24V-K-5,0-OE	5	2.9	5	50	29.3	26.3	1.5
CRSMT-8M-PS-24V-K-10,0-OE							

Proximity sensors CRSMT-8M, for T-slot

Technical data – Magneto-resistive



Dimensions with plug Download CAD data → www.festo.com

Legend:

- 1 Yellow LED
- 2 Orange LED
- 3 Centre of the sensor element
- 4 Slot for screwdriver
- 5 Connecting cable
- 6 Plug module M8D

L1 Cable length

Type	B1	D1 - Ø	D2	D3	H1	L2	L3	L4	≈C 1
CRSMT-8M-PS-24V-K-0,3-M8D	5	2.9	9.5	M8x1	5	41.1	29.3	26.3	1.5

Dimensions with plug Download CAD data → www.festo.com

Legend:

- 1 Yellow LED
- 2 Orange LED
- 3 Centre of the sensor element
- 4 Slot for screwdriver
- 5 Connecting cable
- 6 Plug module M12, 3-pin

L1 Cable length

Type	B1	D1 - Ø	D2 - Ø	D3	H1	L2	L3	L4	≈C 1
CRSMT-8M-PS-24V-K-0,3-M12	5	2.9	15	M12x1	5	54.5	29.3	26.3	1.5

Ordering data							
	Switching output	Electrical connection		Cable length [m]	Weight [g]	Part No.	Type
		Cable	Cable with plug, rotatable thread				
N/O contact, corrosion resistant							
	PNP	3-wire	-	5	47.6	574380	CRSMT-8M-PS-24V-K-5,0-OE
	PNP	3-wire	-	10	93.4	574381	CRSMT-8M-PS-24V-K-10,0-OE
	PNP	3-pin	M12x1	0.3	9.1	574382	CRSMT-8M-PS-24V-K-0,3-M12
	PNP	3-pin	M8x1	0.3	16.1	574383	CRSMT-8M-PS-24V-K-0,3-M8D

Proximity sensors CRSMT-8/SMT-8-SL, for T-slot

Technical data – Magneto-resistive

Function

e.g. PNP, N/O contact, with plug

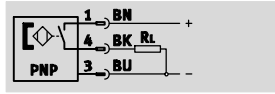

- Magneto-resistive measuring principle
- Insertable in the slot lengthwise
- Corrosion-resistant designs

SMT-8-SL

- Sturdy thanks to long guides
- Plug directly on sensor



CRSMT



SMT-8-SL

General technical data		
Type	CRSMT	SMT-8-SL
Switching output	PNP	PNP
Design	For T-slot	For T-slot
Conforms to standard	EN 60947-5-2	–
Based on standard	–	EN 60947-5-2
Certification	RCM trademark	RCM trademark
	–	c UL us - listed (OL)
CE marking (see declaration of conformity)	To EU EMC Directive	To EU EMC Directive
Note on materials	Free of copper and PTFE	Free of copper and PTFE
	–	RoHS-compliant

Input signal/measuring element		
	CRSMT	SMT-8-SL
Measuring principle	Magneto-resistive	Magneto-resistive
Ambient temperature [°C]	–20 ... +60	–20 ... +70

Switching output		
Type	CRSMT	SMT-8-SL
Switching output	PNP	PNP
Switching output	PNP	PNP
Switching element function	N/O contact	N/O contact
Reproducibility of switching value [mm]	±0.1	–
Switch-on time [ms]	≤ 0.2	≤ 1
Switch-off time [ms]	≤ 0.5	3 ... 5
Max. switching frequency [Hz]	1,000	140
Max. output current [mA]	100	100
Max. switching capacity DC [W]	3	3
Voltage drop [V]	≤ 1.8	≤ 2
Residual current [µmA]	≤ 100	≤ 1.5

Output, additional data		
Type	CRSMT	SMT-8-SL
Switching output	PNP	PNP
Protection against short circuit	Yes	Yes
Overload protection	–	Yes

Proximity sensors CRSMT-8/SMT-8-SL, for T-slot

FESTO

Technical data – Magneto-resistive

Electronic components		
Type	CRSMT	SMT-8-SL
Switching output	PNP	PNP
Rated operating voltage [V DC]	–	24
Operating voltage range [V DC]	10 ... 30	10 ... 30
Reverse polarity protection	For all electrical connections	

Electromechanical components		
Type	CRSMT	SMT-8-SL
Switching output	PNP	PNP
Electrical connection	Cable, 3-wire	Plug M8x1, 3-pin
Connection direction	–	In-line
Cable length [m]	2.5	–
	5	
Cable sheath materials	TPE-O	–

Mechanical components		
Type	CRSMT	SMT-8-SL
Switching output	PNP	PNP
Electrical connection	Cable, 3-wire	Plug M8x1, 3-pin
Type of mounting	Clamped in T-slot	Screw-clamped
	–	Insertable in the slot lengthwise
Housing material information	High-alloy stainless steel	PA
	PP	–

Display/operation	
Switching status indication	Yellow LED

Immissions/emissions		
Type	CRSMT	SMT-8-SL
Ambient temperature with flexible cable installation [°C]	–5 ... +60	–
Degree of protection	IP65	IP65
	IP68	IP68
	IP69K	–
Insulation voltage [V]	500	–
Degree of contamination	3	–
Corrosion resistance class CRC	4	3

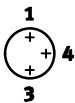
Pin allocation to EN 60947-5-2			
PS/NS			
Plug, 3-pin			
M8x1	Pin	Wire colour	Allocation
	1	Brown	+
	3	Blue	–
	4	Black	Output

Proximity sensors CRSMT-8/SMT-8-SL, for T-slot

Technical data – Magneto-resistive

Dimensions

Download CAD data → www.festo.com

CRSMT

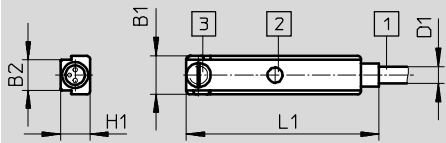

- 1 Connecting cable
- 2 Yellow LED
- 3 Clamping component

SMT-8-SL

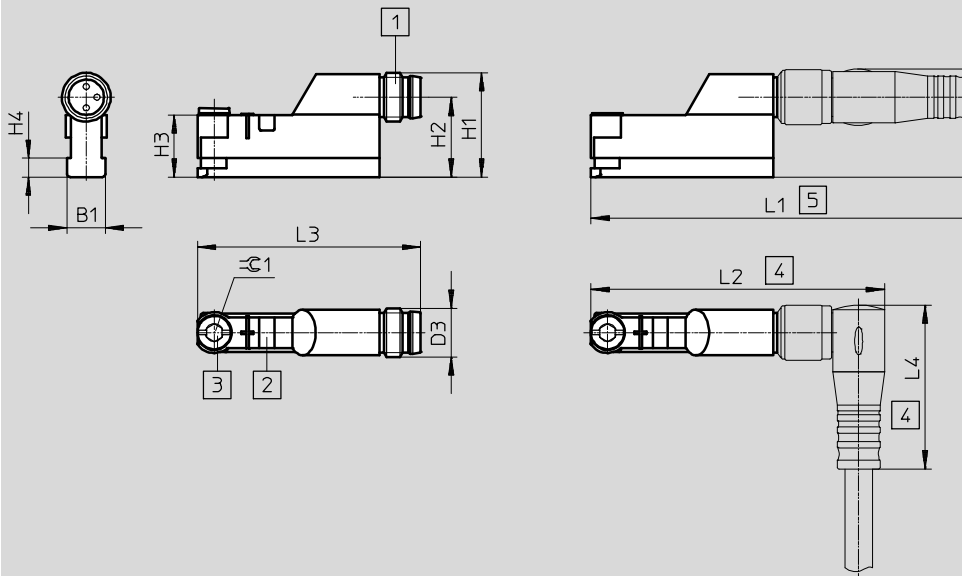

- 1 Plug to fit connecting cable NEBU-M8
- 2 Yellow LED
- 3 Clamping component
- 4 Installation space for connecting cable NEBU-M8W3
- 5 Installation space for connecting cable NEBU-M8G3

Type	B1	B2	D1	D3	H1	H2	H3	H4	H5	L1	L2	L3	L4
CRSMT	6.3	5	2.9	-	4.9	-	-	-	-	32.4	-	-	-
SMT-8-SL	6.7	-	-	M8x1	17.1	13.1	10.2	3.1	17.6	66	48.4	36.6	25

Proximity sensors CRSMT-8/SMT-8-SL, for T-slot

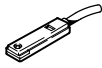

Technical data – Magneto-resistive

Ordering data							
	Switching output	Electrical connection			Cable length [m]	Part No.	Type
		Cable	Cable with plug M8x1	Plug M8x1			
N/O contact, basic version							
	PNP	–	–	3-pin	–	562019 SMT-8-SL-PS-LED-24-B	
N/O contact, corrosion resistant							
	PNP	3-wire	–	–	2.5	525563 CRSMT-8-PS-K-LED-24	
					5.0	525564 CRSMT-8-PS-K5-LED-24	

Proximity sensors SME-8, for T-slot

Technical data – Magnetic reed

Function

e.g. N/O contact, with cable, 3-wire

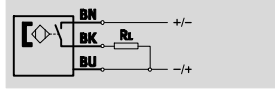

e.g. N/O contact, with plug, 3-pin

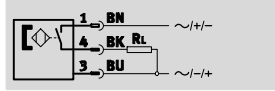

- Magnetic reed measuring principle
- Insertable in the slot lengthwise

SME-8-SL

- Sturdy thanks to long guides
- Plug directly on sensor



General technical data					
Type	SME-8-K	SME-8-S	SME-8-ZS	SME-8-O	SME-8-SL
Design	For T-slot				
Conforms to standard	EN 60947-5-2				
Certification	RCM trademark				
CE marking (see declaration of conformity)	To EU EMC Directive ¹⁾				
Note on materials	Free of copper and PTFE				
	RoHS-compliant	–	RoHS-compliant		

1) For information about the applicability of the component see the manufacturer's EC declaration of conformity at: www.festo.com/sp → Certificates.
If the component is subject to restrictions on usage in residential, office or commercial environments or small businesses, further measures to reduce the emitted interference may be necessary.

Input signal/measuring element								
Type	SME-8-K	SME-8-K5	SME-8-K-7,5	SME-8-S	SME-8-ZS	SME-8-O	SME-8-SL	
Measuring principle	Magnetic reed							
Ambient temperature	[°C]	–40 ... +60	–40 ... +70	–40 ... +70	–40 ... +70	–40 ... +60	–40 ... +60	–40 ... +60

Switching output					
Type	SME-8-K	SME-8-S	SME-8-ZS	SME-8-O	SME-8-SL
Switching output	Contacting, bipolar				
Switching element function	N/O contact	N/O contact	N/O contact	N/C contact	N/O contact
Reproducibility of switching value	[mm]	±0.1	±0.1	±0.1	±0.1
Switch-on time	[ms]	≤ 0.5	≤ 0.5	≤ 0.5	≤ 2
Switch-off time	[ms]	≤ 0.03	≤ 0.03	≤ 0.03	≤ 0.2
Max. switching frequency	[Hz]	800	–	800	–
Max. output current	[mA]	500	500	80	50
Max. switching capacity AC	[VA]	10	10	–	1.5
Max. switching capacity DC	[W]	10	10	2.16	1.5
Voltage drop	[V]	0	–	≤ 3.5	≤ 2.5

Output, additional data	
Protection against short circuit	No
Overload protection	No

Electronic components					
Type	SME-8-K	SME-8-S	SME-8-ZS	SME-8-O	SME-8-SL
Operating voltage range	[V AC]	12 ... 30	12 ... 30	–	12 ... 30
Operating voltage range	[V DC]	12 ... 30	12 ... 30	12 ... 27	12 ... 30
Reverse polarity protection	No				

Proximity sensors SME-8, for T-slot

Technical data – Magnetic reed

Electromechanical components							
Type	SME-8-K	SME-8-K5	SME-8-K-7,5	SME-8-S	SME-8-ZS	SME-8-O	SME-8-SL
Electrical connection	Cable, 3-wire			Cable with plug M8x1, 3-pin	Cable, 2-wire	Cable, 3-wire	Plug M8x1, 3-pin
Connection direction	In-line						
Cable length [m]	2.5	5	7.5	0.3	2.5	7.5	–
Cable sheath materials	TPE-U (PUR)						–

Mechanical components							
Type	SME-8-K	SME-8-K5	SME-8-K-7,5	SME-8-S	SME-8-ZS	SME-8-O	SME-8-SL
Type of mounting	Clamped in T-slot Insertable in the slot lengthwise						
Housing material information	Epoxy resin PC PET High-alloy stainless steel						

Display/operation	
Switching status indication	Yellow LED

Immissions/emissions							
Type	SME-8-K	SME-8-K5	SME-8-K-7,5	SME-8-S	SME-8-ZS	SME-8-O	SME-8-SL
Ambient temperature with flexible cable installation [°C]	–5 ... +60	–5 ... +70	–5 ... +70	–5 ... +70	–5 ... +60	–5 ... +60	–
Degree of protection	IP65			–	IP65	–	IP65
	IP67			IP67	IP67	IP67	IP67
Insulation voltage [V]	50						
Surge resistance [kV]	3	3	3	3	3	3	3
Degree of contamination	3						

Pin allocation to EN 60947-5-2			
S			
Plug, 3-pin			
M8x1	Pin	Wire colour	Allocation
	1	Brown	+
	3	Blue	–
	4	Black	Output

Proximity sensors SME-8, for T-slot

Technical data – Magnetic reed

Dimensions

Download CAD data → www.festo.com

N/O contact, cable

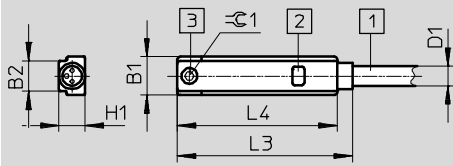

- 1 Connecting cable, 3 wire cable, 3 x 0.14 mm²
- 2 Yellow LED
- 3 Max. tightening torque 0.2 Nm

Type	B1	B2	D1 ∅	H1	L3	L4	≈ 1
SME-8-K- ...	6.4	5	2.9	4.3	28.8	26.3	1.3

Dimensions

Download CAD data → www.festo.com

N/C contact, cable

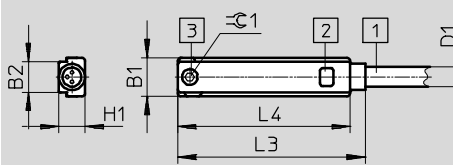

- 1 Connecting cable, 3 wire cable, 3 x 0.14 mm²
- 2 Yellow LED
- 3 Max. tightening torque 0.2 Nm

Type	B1	B2	D1 ∅	H1	L3	L4	≈ 1
SME-8-O-K-LED-24	6.4	5	2.9	4.4	30.8	28.3	1.3

Dimensions

Download CAD data → www.festo.com

Plug M8x1

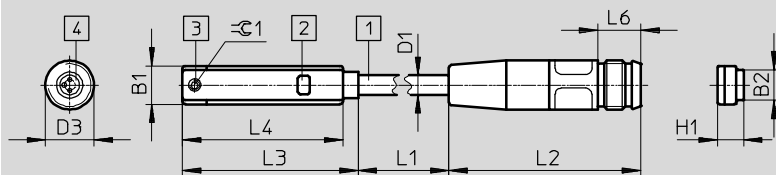



- 1 Connecting cable
- 2 Yellow LED
- 3 Clamping component
- 4 Plug to fit connecting cable NEBU-M8

L1 Cable length

Type	B1	B2	D1 ∅	D3	H1	L2 +5	L3	L4	L6 min.	≈ 1
SME-8-S-LED-24	6.3	5	2.9	M8	4.7	31	28.8	26.3	6	1.3

Proximity sensors SME-8, for T-slot

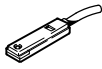
Technical data – Magnetic reed

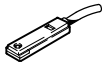
Ordering data							
	Switching output	Electrical connection			Cable length [m]	Part No.	Type
		Cable	Cable with plug M8x1	Plug M8x1			
N/O contact, basic version							
	Contacting, bipolar	3-wire	–	–	2.5	150855	SME-8-K-LED-24
			–	–	5.0	175404	SME-8-K5-LED-24
			–	–	7.5	530491	SME-8-K-7,5-LED-24
		–	3-pin	–	0.3	150857	SME-8-S-LED-24
		2-wire	–	–	2.5	171169	SME-8-ZS-KL-LED-24
	Contacting, bipolar	–	–	3-pin	–	526622	SME-8-SL-LED-24
N/C contact							
	Contacting, bipolar	3-wire	–	–	7.5	160251	SME-8-O-K-LED-24

Proximity sensors SME-8, for T-slot

Technical data – Magnetic reed

Function

e.g. N/O contact, with cable, 2-wire,
0 ... 30 V AC/DC

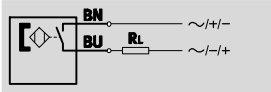

e.g. N/O contact, with cable, 2-wire,
3 ... 230 V AC/DC

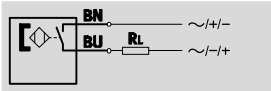

- Magnetic reed measuring principle
- Insertable in the slot lengthwise
- Heat resistant design
- Variants with operating voltage range up to 230 V DC/AC

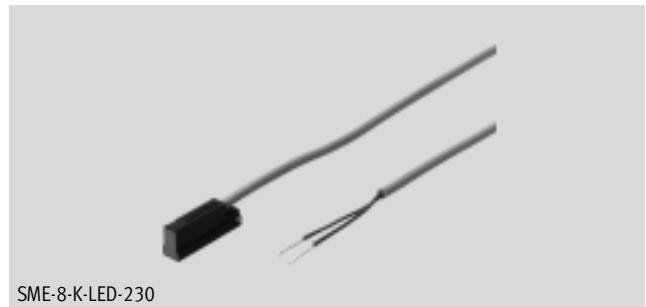

SME-8-K-LED-230

General technical data		
	SME-8-...-S6	SME-8-...-230
Design	For T-slot	
Conforms to standard	EN 60947-5-2	
Certification	–	RCM trademark
CE marking (see declaration of conformity)	–	To EU EMC Directive ¹⁾
	–	To EU Low Voltage Directive
Note on materials	Free of copper and PTFE	
	RoHS-compliant	

1) For information about the applicability of the component see the manufacturer's EC declaration of conformity at: www.festo.com/sp → Certificates.
If the component is subject to restrictions on usage in residential, office or commercial environments or small businesses, further measures to reduce the emitted interference may be necessary.

Input signal/measuring element		
	SME-8-...-S6	SME-8-...-230
Measuring principle	Magnetic reed	
Ambient temperature	[°C] –40 ... +120	–30 ... +60

Switching output		
	SME-8-...-S6	SME-8-...-230
Switching output	Contacting, bipolar	Contacting, bipolar
Switching element function	N/O contact	
Reproducibility of switching value	[mm] ±0.1	±0.1
Switch-on time	[ms] ≤ 0.5	2
Switch-off time	[ms] ≤ 0.03	0.03
Max. switching frequency	[Hz] 800	500
Max. output current	[mA] 500	120
Max. switching capacity AC	[VA] 10	
Max. switching capacity DC	[W] 10	
Voltage drop	[V] ≤ 0	≤ 3.9
Residual current	[mA] –	0

Proximity sensors SME-8, for T-slot

FESTO

Technical data – Magnetic reed

Output, additional data		
	SME-8-...-S6	SME-8-...-230
Protection against short circuit	No	
Overload protection	No	

Electronic components		
	SME-8-...-S6	SME-8-...-230
Operating voltage range [AC V]	0 ... 30	3 ... 230
Operating voltage range [V DC]	0 ... 30	3 ... 230
Reverse polarity protection	No	

Electromechanical components		
	SME-8-...-S6	SME-8-...-230
Electrical connection	Cable, 2-wire	
Connection direction	In-line	
Cable length [m]	2.5	2.5
	–	–
Cable sheath materials	TPE-S	TPE-U (PUR)

Mechanical components		
	SME-8-...-S6	SME-8-...-230
Type of mounting	Clamped in T-slot Insertable in the slot lengthwise	
Housing material information	Epoxy resin	Epoxy resin
	PC	PS
	PET	PET
	High-alloy stainless steel	High-alloy stainless steel

Display/operation		
	SME-8-...-S6	SME-8-...-230
Switching status indication	–	Yellow LED

Immissions/emissions		
	SME-8-...-S6	SME-8-...-230
Ambient temperature with flexible cable installation [°C]	–5 ... +120	–5 ... +60
Ambient temperature	–40 ... +120	–
Degree of protection	–	–
	IP67	IP67
Insulation voltage [V]	50	–
Surge resistance [kV]	0.8	4
Degree of contamination	3	3

Proximity sensors SME-8, for T-slot

Technical data – Magnetic reed

Dimensions

Download CAD data → www.festo.com

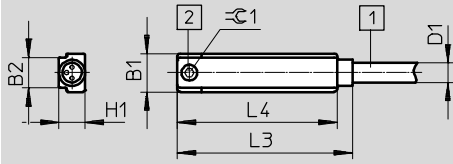

- 1 Connecting cable, 3 wire cable, 3 x 0.14 mm²
- 2 Max. tightening torque 0.2 Nm

Type	B1	B2	D1 ∅	H1	L3	L4	∅ 1
	±0.05	-0.08	±0.05 ... -0.1	-0.1		+0.2	
SME-8- ... -S6	6.4	5	2.9	4.3	28.8	26.3	1.3

Dimensions

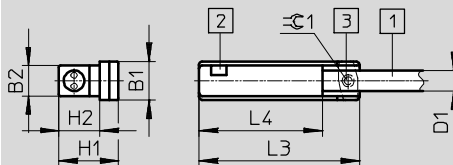

Download CAD data → www.festo.com



- 1 Connecting cable
- 2 Yellow LED
- 3 Max. tightening torque 0.2 Nm

Type	B1	B2	D1 ∅	H1	H2	L3	L4	∅ 1
SME-8-K-LED-230	6.4	5	3.4	9.8	6.7	26.2	20.2	1.3

Ordering data

	Switching output	Electrical connection	Connection direction	Cable length [m]	Part No.	Type
		Cable				
N/O contact, heat resistant						
	Contacting, bipolar	2-wire	In-line	2.5	161756	SME-8-K-24-S6
N/O contact, operating voltage range up to 230 V AC/DC						
	Contacting, bipolar	2-wire	In-line	2.5	152820	SME-8-K-LED-230

Proximity sensors SMT-8G, for T-slot

Type codes

SMT-8G

SMT - 8G - PS - 24V - E - 2,5Q - OE

Function	
SMT	Proximity sensor, magneto-resistive

Design	
8G	For T-slot, insertable in the slot lengthwise

Switching output, switching element function	
PS	PNP, N/O contact, 3-wire

Rated operating voltage	
24V	24 V DC

Cable characteristics	
E	Energy chain + robot

Cable length [m], connection direction	
2,5Q	Cable, 2.5 m, lateral ¹⁾
0,3Q	Cable with plug, 0.3 m, lateral ²⁾

Electrical connection	
OE	Open end
M8D	Cable with plug M8x1, rotatable thread

- 1) Only with electrical connection OE
- 2) Not with electrical connection OE

Proximity sensors SMT-8G, for T-slot

Technical data – Magneto-resistive

Function

PNP, N/O contact, with cable, 3-wire

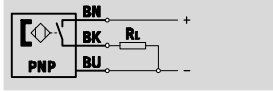

E.g. PNP, N/O contact, with plug

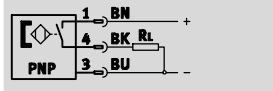

- Magneto-resistive measuring principle
- Insertable in the slot lengthwise
- Design ideal for gripper sensing

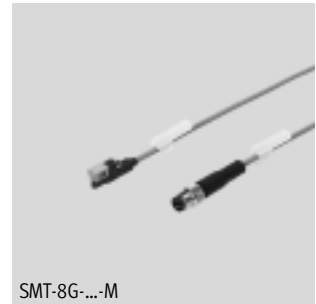
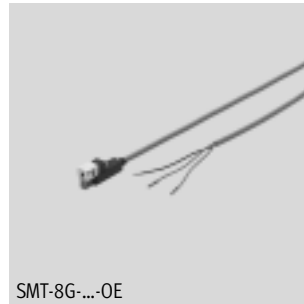

General technical data	
Design	For T-slot
Based on standard	EN 60947-5-2
Approval certificate	c UL us - listed (OL)
CE marking (see declaration of conformity)	To EU EMC Directive
Note on materials	Free of copper and PTFE RoHS-compliant

Input signal/measuring element	
Measuring principle	Magneto-resistive
Ambient temperature [°C]	-20 ... +70

Switching output	
Switching output	PNP
Switching element function	N/O contact
Max. output current [mA]	80
Max. switching capacity DC [W]	2.4

Output, additional data	
Protection against short circuit	Pulsed
Overload protection	Yes

Electronic components	
Operating voltage range [V DC]	10 ... 30
Reverse polarity protection	For all electrical connections

Electromechanical components		
Type	SMT-8G-...-OE	SMT-8G-...-M8D
Electrical connection	Cable, 3-wire	Cable with plug M8x1, 3-pin, rotatable thread
Connection direction	Lateral	
Cable test conditions	Energy chain: 5 million cycles, bending radius 28 mm	
	Torsional strength: > 300,000 cycles, ±270°/0.1 m	
	Resistance to bending: to Festo standard; test conditions on request	
Cable length [m]	2.5	0.3
Cable characteristics	Energy chain + robot	
Cable sheath materials	Thermoplastic polyurethane elastomer	

Mechanical components	
Type of mounting	Clamped in T-slot
	Insertable in the slot lengthwise
Housing material information	Reinforced PA

Proximity sensors SMT-8G, for T-slot

Technical data – Magneto-resistive



Display/operation	
Switching status indication	Yellow LED

Immissions/emissions	
Ambient temperature with flexible cable installation	°C -5 ... +70
Degree of protection	IP65 IP68

Pin allocation to EN 60947-5-2			
PS			
Plug, 3-pin			
M8x1	Pin	Wire colour	Allocation
	1	Brown	+
	3	Blue	-
	4	Black	Output

Download CAD data → www.festo.com

1 Light-emitting diode (LED) 3 Inscription label holder 4 Connecting cable
 2 SMT-8G 5 Plug M8x1

	B1	B2	B3	B4	D1 ∅	D2 ∅	D3	H1	H2	L1	L2 ±0.4	L3 ±0.3	L4	L5	L6 +5	L7	≈±1
SMT-8G-...-OE	5.4	5	6.3	5	2.9	-	-	10	5	2500 + 70	-	25	14.4	23	50	2.5	1.5
SMT-8G-...-M8D						9.6	M8x1			300 + 30	41.1				-		

Ordering data						
	Switching output	Electrical connection		Cable length [m]	Part No.	Type
		Cable	Cable with plug, rotatable thread M8x1			
N/O contact						
	PNP	3-wire	-	2.5	547859	SMT-8G-PS-24V-E-2,5Q-OE
		-	3-pin	-	0.3	547860

Proximity sensors SMT-8F-I, to EU Explosion Protection Directive (ATEX)

Technical data

Function
Namur, with cable

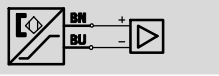

- EU conformity to EU EMC Directive, to EU Explosion Protection Directive (ATEX)
- Magneto-inductive measuring principle
- Insertable in the slot from above
- Cable clip included in the scope of delivery

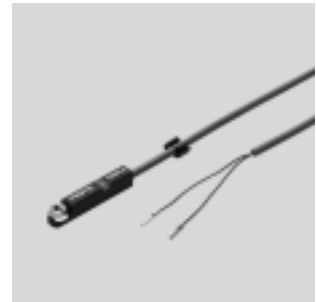

Technical data	
Switching element function	NAMUR
Switching output	NAMUR
Design	For T-slot
Type of mounting	Clamped in T-slot
Reproducibility of switching value ¹⁾	[mm] ±0.1
Electrical connection	Cable, 2-wire
Assembly position	Any
Cable length	[m] 5
Rated operating voltage	[V DC] 8.2
Max. output current in Namur operation	[mA] 4.5
Residual current	[mA] < 0.7
Switch-on time	[ms] ≤ 0.5
Switch-off time	[ms] ≤ 0.5
Protection against short circuit	For all electrical connections
Reverse polarity protection	
Conforms to standard	EN 60947-5-6
Certificate issuing authority	KEMA 04 ATEX 1114 X
Switching status indication	Yellow LED
Product weight	[g] 70

1) Only applicable to drives secured against rotation

Operating and environmental conditions		
Cable installation	Fixed	Flexible
Ambient temperature	[°C] -25 ... +70	-5 ... +70
Degree of protection	IP65, IP67	
Approval certificate	C-Tick	

Note
When used in hazardous areas, the proximity sensor SMT-8F-I must always be operated with an isolated switch amplifier according to DIN EN 60 947-5-6.

Note
Operating instructions, declarations and statements of conformity
→ www.festo.com

Proximity sensors SMT-8F-I, to EU Explosion Protection Directive (ATEX)

FESTO

Technical data

ATEX	
ATEX category for gas	II 1G
Explosion ignition protection type for gas	Ex ia IIC T4 ... T6 Ga
ATEX category for dust	II 1D
Explosion ignition protection type for dust	Ex ia IIIC T95°C Da
Explosion-proof temperature [°C]	-10°C ≤ Ta ≤ +70°C
Explosion protection certification outside the EU	GOST-R EPL Ga
CE marking (see declaration of conformity)	To EU EMC Directive
	To EU Explosion Protection Directive (ATEX)

Materials	
Housing	PA
Cable sheath	PVC
Note on materials	Free of copper and PTFE

Dimensions

The drawing shows a side view and a front view of the sensor. Dimensions include L4 (LED length), L3 (total length), H1 (height), B1 (width), and D1 (cable diameter). Callouts 1-4 identify the LED, switching point, clamping component, and cable.

Download CAD data → www.festo.com

- 1 Yellow LED for switching status
- 2 Switching point
- 3 Clamping component, max. tightening torque 0.6 Nm
- 4 Cable

Type	B1	D1	H1	L1	L2	≈ 1
SMT-8F-I-8 ...	5	2.9 ∅	6	31.8	6.2	1.5

Ordering data						
	Switching output	Electrical connection	Cable length [m]	Part No.	Type	
	Namur	Cable, 2-wire	5.0	536 956	SMT-8F-I-8,2V-K5,0-OE-Ex	

Proximity sensors SME-8-FM, for T-slot

Type codes

SME-8-FM

SME – 8 – FM – DS – 24V – K – 1,0 – OE

Function	
SME	Proximity sensor, magnetic reed

Design	
8	For T-slot

Sensor design	
FM	Screw-clamped, insertable in the slot from above

Switching output	
DS	3-wire N/O contact
ZS	2-wire N/O contact

Nominal operating voltage	
24V	24 V AC/DC

Cable characteristics	
K	Standard

Cable length [m]	
1,0	1

Electrical connection	
OE	Open end

Proximity sensors SME-8-FM, for T-slot

Technical data – Magnetic reed

FESTO

Function

N/O contact, with cable, 3-wire

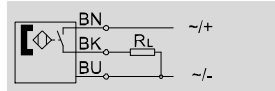

N/O contact, with cable, 2-wire

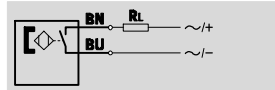

- Magnetic reed measuring principle
- Insertable in the slot from above



SME-8-FM-DS



SME-8-FM-ZS

General technical data	
Design	For T-slot
Based on standard	EN-60947-5-2
Certification	RCM trademark
CE marking (see declaration of conformity)	To EU EMC Directive
Note on materials	Free of copper and PTFE RoHS-compliant

Input signal/measuring element	
Measuring principle	Magnetic reed
Ambient temperature [°C]	-10 ... +60

Switching output		
Type	SME-8-FM-DS	SME-8-FM-ZS
Switching output	Contacting, bipolar	
Switching element function	N/O contact	
Max. output current [mA]	100	
Max. switching capacity AC [VA]	3	
Max. switching capacity DC [W]	3	

Output, additional data	
Protection against short circuit	No
Overload protection	No

Electronic components		
Operating voltage range [AC V]	10 ... 30	
Operating voltage range [V DC]	10 ... 30	

Electromechanical components		
Type	SME-8-FM-DS	SME-8-FM-ZS
Electrical connection	Cable, 3-wire	Cable, 2-wire
Connection direction	In-line	
Cable test conditions	Test conditions on request	
Cable length [m]	1	
Cable characteristics	Standard	
Cable sheath materials	PVC	

Mechanical components		
Type	SME-8-FM-DS	SME-8-FM-ZS
Type of mounting	Screw-clamped Insertable in the slot from above	
Housing material information	PA	

Proximity sensors SME-8-FM, for T-slot

Technical data – Magnetic reed

Display/operation	
Switching status indication	Yellow LED

Immissions/emissions	
Ambient temperature with flexible cable installation	[°C] -5 ... +60
Degree of protection	IP67

Dimensions Download CAD data → www.festo.com

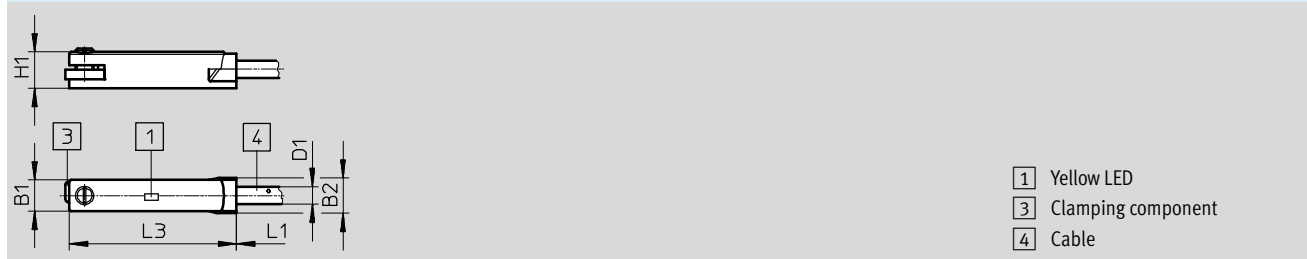

	B1	B2	D1	H1	L1	L2
SME-8-FM	5.1	5.8	2.9	6	27.4	1,000

Ordering data						
	Switching output	Electrical connection	Cable length [m]	Part No.	Type	
		Cable				
	Contacting, bipolar	3-wire	1	562515	SME-8-FM-DS-24V-K-1,0-OE	
		2-wire	1	562516	SME-8-FM-ZS-24V-K-1,0-OE	

Proximity sensors SDBT-BSW-..., for T-slot

Type codes

SDBT-BSW	
SDBT – BSW – 1 L – – W – – – –	
Function	
SDBT	Sensor, position, binary, T series
Sensor design	
B	Insertable in slot, clamp at rear
S	Non-contacting
W	Welding field immune
Nominal operating voltage	
1	24 V DC
Display	
L	LED
Digital switching output	
PU	3-wire N/O contact, PNP
NU	3-wire N/O contact, NPN
ZU	2-wire N/O contact
Cable characteristic	
W	Resistant to welding spatter
Cable length	
0,3	0.3 m
5	5 m
Cable designation	
N	Without inscription label holder
Electrical connection	
LE	Open end
M12	Plug connector M12, A-coded

Proximity sensors SDBT-BSW-..., for T-slot

Technical data – Magneto-resistive

Function

e.g.:... -PU-...-LE

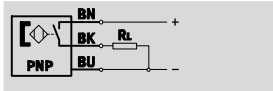

e.g.:... -NU-...-M12

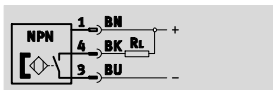

- Oil-resistant
- Welding field immune, AC 50 ... 60 Hz, MFDC 1000 Hz
- Resistant to welding spatter
- Resistant to UV radiation



Note

- For contactless piston-rod position sensing in Festo pneumatic cylinders, in particular the hinge cylinder DFAW for AMI, in low and medium frequency welding installations (50/60 Hz, 1000 Hz) with strong constant or alternating magnetic fields.
- When using the SDBT-BSW on drives other than the DFAW series, multiple switching can occur.
- The SDBT-BSW-...-ZU-... (2-wire version for 50/60 Hz AC) can be used on all drives.
- The SDBT-BSW-...-PU/NU-... (3-wire version for 50/60 Hz AC and 1000 Hz MFDC) can be used on the following drives (see table). For drives that are not listed, reliable functioning cannot be guaranteed. The application range should be checked where necessary.

SDBT-BSW-...-PU/NU-... (3-wire version for 50/60 Hz AC and 1000 Hz MFDC)														
Drive	∅ [mm]	8	10	12	16	18	20	25	32	40	50	63	80	100
DFAW		-	-	-	-	-	-	-	-	-	■	■	■	-
DSBC		-	-	-	-	-	-	-	■	■	-	-	-	-
ADN		-	-	■	■	-	■	■	■	■	■	-	-	-
ADVU		-	-	■	■	-	■	■	■	■	■	-	-	-
DFM		-	-	■	■	-	■	■	■	■	■	■	-	-
DSBG		-	-	-	-	-	-	-	■	■	■	■	-	■
DSNU		■	■	■	■	-	■	■	■	■	■	-	-	-
DGC-K		-	-	-	-	■	-	■	-	-	-	-	-	-

General technical data	
Design	For T-slot
Based on standard	EN 60947-5-2
Approval	RCM mark c UL us - Listed (OL)
Special characteristics	Oil-resistant Welding field immune Resistant to welding spatter Resistant to UV radiation
Switching characteristics during the welding process	Output signal freezes
CE marking (see declaration of conformity)	To EU EMC Directive
Note on materials	Free of copper and PTFE, RoHS-compliant

Input signal/measuring element	
Measuring principle	Magneto-resistive
Measured variable	Position
Ambient temperature [°C]	-25 ... +85

Signal processing	
Max. travel speed [m/s]	1

Proximity sensors SDBT-BSW-..., for T-slot

FESTO

Technical data – Magneto-resistive

Switching output		...-PU-...	...-NU-...	...-ZU-...
Switching element function		N/O contact		
Switching output repetition accuracy	[mm]	±0.1		
Switch-on time	[ms]	≤15		
Switch-off time	[ms]	≤25		
Max. switching frequency	[Hz]	25		
Max. output current	[mA]	100	80	
Max. output current in mounting kits	[mA]	100	80	
Max. switching capacity DC	[W]	2.8	1.9	
Max. switching capacity DC in mounting kits	[W]	2.8	1.9	
Voltage drop	[V]	<1.5	<6	
Minimum load current	[mA]	0	2.4	
Residual current	[mA]	<0.005	<0.14	<0.7

Output, additional data	
Protection against short circuit	Yes, pulsed
Overload protection	Yes

Electronic components	
Switching output	PNP
Rated operating voltage	[V DC] 24
Operating voltage range	[V DC] 10 ... 30
Reverse polarity protection	For all electrical connections

Electromechanical components	...-PU/ NU-...-M12	...-PU/ NU-...-LE	...-ZU-...-LE
Electrical connection	Cable with plug connector, 3-pin, M12x1, rotatable thread	Cable, 3-wire	Cable, 2-wire
Connection direction	In-line		
Cable characteristic	Resistant to welding spatter		
Cable test conditions	Test conditions on request		

Proximity sensors SDBT-BSW-..., for T-slot

Technical data – Magneto-resistive

Mechanical system		...-PU/ NU-...-M12	...-PU/ NU-...-LE	...-ZU-...-LE
Type of mounting	Screw-clamped, insertable in the slot from above			
Mounting position	Any			
Max. tightening torque	[Nm]	0.6		
Max. tightening torque plug connector	[Nm]	0.5	–	–
Information on materials				
Housing	Epoxy resin, high-alloy stainless steel, PA reinforced, black			
Union nut	Nickel-plated brass		–	–
Cable sheath	PVC, irradiated grey			
Insulating sheath	PVC			
Plug housing	TPE-U(PU)		–	–
Wire ends	–		Wire end sleeve	Wire end sleeve
Pin contacts	Nickel-plated and gold-plated brass		–	–

Display/operation	
Switching status display	Yellow LED
Operating reserve display	Orange LED

Immissions/emissions		
Ambient temperature with flexible cable installation	[°C]	–5 ... +80
Degree of protection		IP65 IP68
Resistance to interference from magnetic fields	[ZU]	Design insensitive to permanent magnetic fields < Bon Insensitive to alternating magnetic fields (50 ... 60 Hz) < 160 mT
	[PU/NU]	Insensitive to MFDC magnetic fields (1000 Hz) < 200 mT, insensitive to alternating magnetic fields (50 ... 60 Hz) < 200 mT

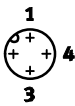
Pin allocation to EN 60947-5-2			
M12x1, 3-pin			
N/O contact			
	Pin	Wire colour	Allocation
	1	Brown	+
	3	Blue	–
	4	Black	Outlet

Proximity sensors SDBT-BSW-..., for T-slot

Technical data – Magneto-resistive

Dimensions open end

Download CAD data → www.festo.com

SDBT-BSW-1L-...-W-5-N-LE

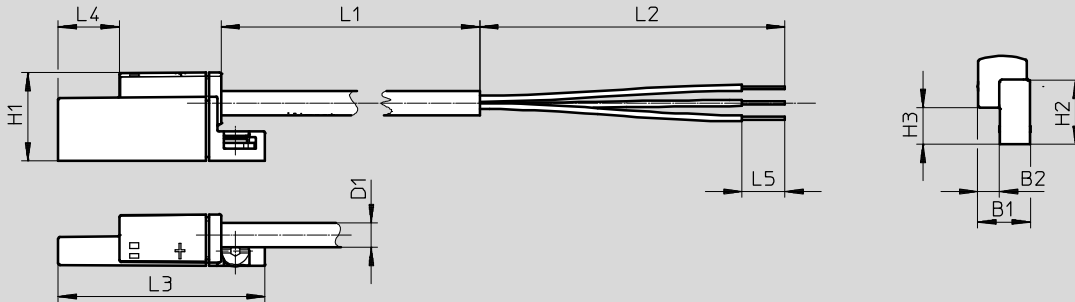

SDBT-BSW-1L-ZU-W-5-N-LE



Type	B1	B2	D1 - σ	H1	H2	H3	L1	L2	L3	L4	L5
SDBT-BSW-1L-PU-W-5-N-LE	8.5	3.5	4	14.5	10.5	6	5000	50	34	10	7
SDBT-BSW-1L-ZU-W-5-N-LE											
SDBT-BSW-1L-NU-W-5-N-LE											

Dimensions with plug connector

Download CAD data → www.festo.com

SDBT-BSW-1L-...-W-0,3-N-M12

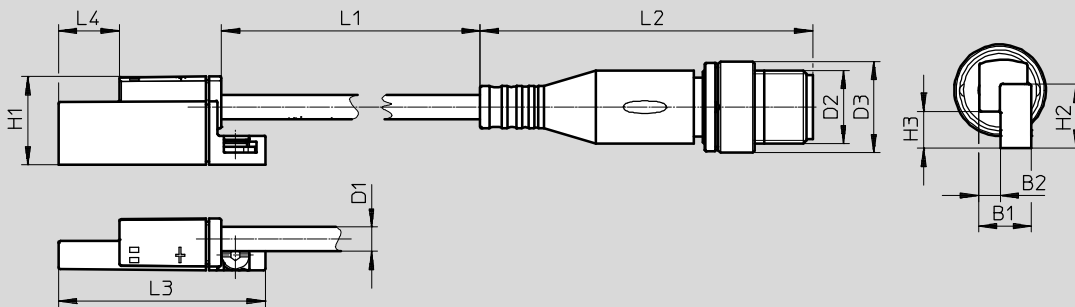



Type	B1	B2	D1 - σ	D2	D3 - σ	H1	H2	H3	L1	L2	L3	L4
SDBT-BSW-1L-PU-W-0,3-N-M12	8.5	3.5	4	M12	15	14.5	10.5	6	300	54.5	34	10
SDBT-BSW-1L-NU-W-0,3-N-M12												

Proximity sensors SDBT-BSW-..., for T-slot

Technical data – Magneto-resistive

Ordering data					
	Switching output	Cable length	Weight	Part No.	Type
		[m]	[g]		
N/O contact					
	3-wire, NPN	0.3	23.3	2427615	SDBT-BSW-1L-NU-W-0.3-N-M12
	3-wire, PNP	5	119.4	2427616	SDBT-BSW-1L-PU-W-5-N-LE
	3-wire, NPN	5	119.4	2427618	SDBT-BSW-1L-NU-W-5-N-LE
	3-wire, PNP	0.3	23.3	2476855	SDBT-BSW-1L-PU-W-0.3-N-M12
	2-wire, contactless	5	116.9	2427617	SDBT-BSW-1L-ZU-W-5-N-LE

Accessories – Connecting cables					
	Switching output	Cable length	Weight	Part No.	Type
		[m]	[g]		
Resistant to welding spatter					
	3-wire, M12x1 straight socket	3	–	30450	SIM-M12-RS-3GD-3
	3-wire, M12x1 angled socket	3	–	30451	SIM-M12-RS-3WD-3

Proximity sensors SMT0/SMTSO/SME0-8E, for T-slot

Type codes

SMT0/SMTSO/SME0-8E	
<div style="display: flex; justify-content: space-around; border-bottom: 1px solid black;"> SMT0 - 8E - PS - M12 - LED - 24 - </div>	
Function	
SMT0	Proximity sensor, magneto-resistive
SMTSO	Proximity sensor, magneto-inductive, welding field immune
SME0	Proximity sensor, magnetic reed
Design	
8E	For T-slot, mounting via accessories
Switching output, switching element function	
PS	PNP, N/O contact, 3-wire
NS	NPN, N/O contact, 3-wire
Electrical connection, cable length	
K	Cable, 2.5 m or 7.5 m
S	Plug M8x1
M12	Plug M12x1
Switching status indication	
LED	Yellow LED
Rated operating voltage	
24	24 V DC
230	230 V AC
Variant	
S6	Heat resistant

Proximity sensors SMTO-8E/SMTSO-8E, for T-slot

Technical data – Magneto-resistive

Function

e.g. PNP, N/O contact, with plug

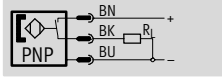

NPN, N/O contact, with plug

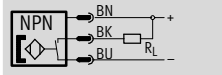

- Magneto-resistive measuring principle
- Welding field immune designs



General technical data		
Type	SMTO-8E	SMTSO-8E, welding field immune
Design	For T-slot	
Approval certificate	RCM trademark	
CE marking (see declaration of conformity)	To EU EMC Directive ¹⁾	
Note on materials	Free of copper and PTFE	
	RoHS-compliant	-

1) For information about the applicability of the component see the manufacturer's EC declaration of conformity at: www.festo.com/sp → Certificates.
If the component is subject to restrictions on usage in residential, office or commercial environments or small businesses, further measures to reduce the emitted interference may be necessary.

Input signal/measuring element		
Type	SMTO-8E	SMTSO-8E, welding field immune
Measuring principle	Magneto-resistive	Magneto-inductive
Ambient temperature [°C]	-20 ... +60	-25 ... +70

Switching output				
Type	SMTO-8E		SMTSO-8E, welding field immune	
Switching output	PNP	NPN	PNP	NPN
Switching element function	N/O contact			
Reproducibility of switching value [mm]	±0.1			
Switch-on time [ms]	0 ... 0.5		0 ... 38	
Switch-off time [ms]	10 ... 25		0 ... 20	
Max. output current [mA]	100		200	
Max. switching capacity DC [W]	3		6	
Voltage drop [V]	0 ... 1.8		0 ... 1.8	0 ... 3
Residual current [µmA]	0.01			

Output, additional data				
Type	SMTO-8E		SMTSO-8E, welding field immune	
Switching output	PNP	NPN	PNP	NPN
Protection against short circuit	Pulsed		Yes	Pulsed
Overload protection	Yes			

Electronic components		
Operating voltage range DC [V]	10 ... 30	
Reverse polarity protection	For all electrical connections	

Proximity sensors SMTO-8E/SMTSO-8E, for T-slot

Technical data – Magneto-resistive

Electromechanical components			
Type	SMTO-8E-...-S	SMTO-8E-...-M12	SMTSO-8E-...-M12, welding field immune
Electrical connection	Plug M8x1, 3-pin	Plug M12x1, 3-pin	Plug M12x1, 3-pin
Connection direction	Lateral		
Max. tightening torque, plug [Nm]	0.3	0.5	0.5

Mechanical components			
Type	SMTO-8E-...-S	SMTO-8E-...-M12	SMTSO-8E-...-M12, welding field immune
Type of mounting	Clamped in T-slot Insertable in the slot from above Via accessories		
Tightening torque [Nm]	1	0.5	0.5
Housing material information	TPE-U(PU)	TPE-U(PU)	TPE-U(PU)
	Nickel-plated brass	High-alloy stainless steel	High-alloy stainless steel
	–	Wrought aluminium alloy	Wrought aluminium alloy
		–	PA

Display/operation	
Switching status indication	Yellow LED

Immissions/emissions			
Type	SMTO-8E-...-S	SMTO-8E-...-M12	SMTSO-8E-...-M12, welding field immune
Degree of protection	IP65 IP67		
Resistance to interference from magnetic fields	–	–	Alternating magnetic field 45 ... 65 Hz

Pin allocation to EN 60947-5-2			
M8x1, 3-pin			
N/O contact			
	Pin	Wire colour	Allocation
	1	Brown	+
	3	Blue	–
	4	Black	Output
M12x1, 3-pin			
N/O contact			
	Pin	Wire colour	Allocation
	1	Brown	+
	3	Blue	–
	4	Black	Output

Proximity sensors SMT0-8E/SMTSO-8E, for T-slot

Technical data – Magneto-resistive

FESTO

Dimensions

Download CAD data → www.festo.com

SMT0-8E-...-S-LED-24 – Plug M8x1

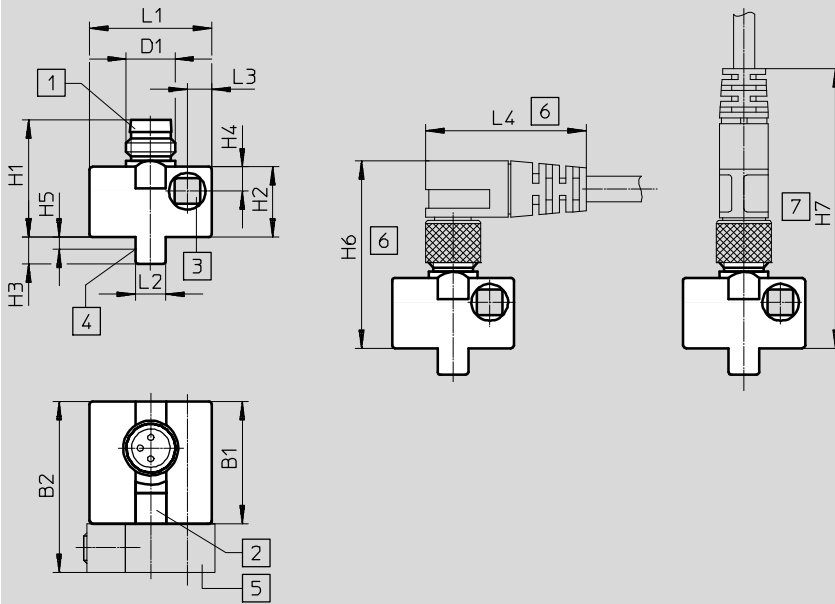

- 1 Suitable for socket type SIM-M8
- 2 Yellow LED
- 3 Socket head screw M3x25 DIN 912, max. tightening torque 1 Nm
- 4 Theoretical switching point
- 5 Mounting kit SMB-8E (not included in scope of delivery)
- 6 Installation space for angled plug socket 90°
- 7 Installation space for straight plug socket

	B1 ±0.3	B2	D1	H1	H2 ±0.27	H3	H4	H5	H6	H7	L1 ±0.3	L2	L3	L4
SMT0-8E-...-S-LED-24	20	28	M8x1	19.2	11.5	4.4	4	2.2	~32	~46	20	5	4	~26

Dimensions

Download CAD data → www.festo.com

SMT0-8E-...-M12-LED-24 – Plug M12x1

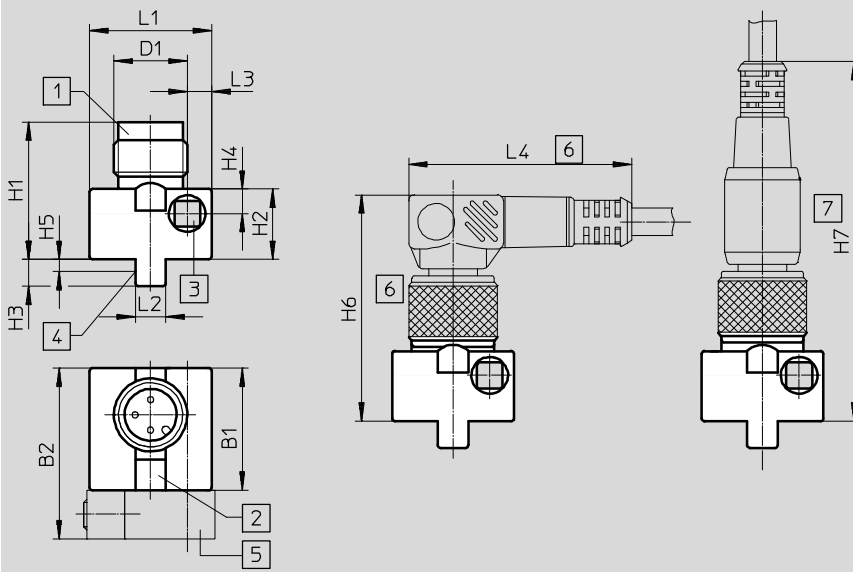

- 1 Suitable for socket type SIM-M12
- 2 Yellow LED
- 3 Socket head screw M3x25 DIN 912, max. tightening torque 1 Nm
- 4 Theoretical switching point
- 5 Mounting kit SMB-8E (not included in scope of delivery)
- 6 Installation space for angled plug socket 90°
- 7 Installation space for straight plug socket

	B1 ±0.3	B2	D1	H1 ±0.34	H2 ±0.27	H3	H4	H5	H6	H7	L1 ±0.3	L2	L3	L4
SMT0-8E-...-M12-LED-24	20	28	M12x1	22.5	11.5	4.4	4	2.2	~36	~59	20	5	4	~36.5

Proximity sensors SMT0-8E/SMTSO-8E, for T-slot

Technical data – Magneto-resistive



Dimensions

Download CAD data → www.festo.com

SMTSO-8E-...-M12-LED-24 – Plug M12x1

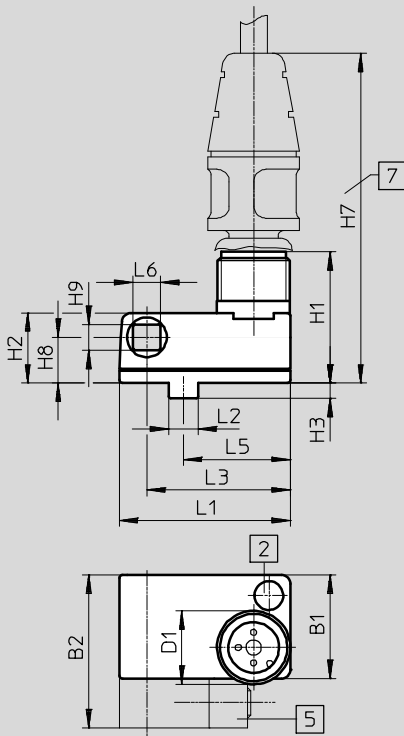

- 2 Yellow LED
- 5 Mounting kit SMB-8E (not included in scope of delivery)
- 7 Installation space for connecting cable NEBU-M12G5



	B1	B2	D1	H1 +0.5	H2	H3 ±0.2	H7	H8	H9	L1	L2	L3	L5	L6
SMT0-8E- ... -M12-LED-24	17	24.8	M12x1	21.5	11.5	2.5	~56	7.5	4.2	28	4.8	23.5	17.5	4.5

Ordering data

	Switching output	Electrical connection		Part No.	Type
		Plug M8x1	Plug M12x1		
N/O contact, basic version					
	PNP	3-pin	–	171178	SMT0-8E-PS-S-LED-24
		–	3-pin	171179	SMT0-8E-PS-M12-LED-24
	NPN	3-pin	–	171166	SMT0-8E-NS-S-LED-24
		–	3-pin	171176	SMT0-8E-NS-M12-LED-24
N/O contact, welding field immune					
	PNP	–	3-pin	191986	SMTSO-8E-PS-M12-LED-24
	NPN	–	3-pin	175825	SMTSO-8E-NS-M12-LED-24

Proximity sensors SMT0-8E/SMTSO-8E, for T-slot

Technical data – Magneto-resistive

Accessories – Connecting cables					
	Switching output	Cable length	Weight	Part No.	Type
		[m]	[g]		
Resistant to welding spatter					
	3-wire, M12x1 straight socket	3	–	30450	SIM-M12-RS-3GD-3
	3-wire, M12x1 angled socket	3	–	30451	SIM-M12-RS-3WD-3

Proximity sensors SMEO-8E, for T-slot

Technical data – Magnetic reed



Function

e.g. N/O contact, 3-wire, with plug

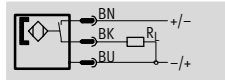

- Magnetic reed measuring principle
- Heat resistant variant

E.g. N/O contact, 2-wire, with cable

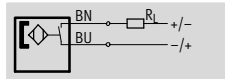

General technical data			
	SMEO-8E-...-24	SMEO-8E-...-24-S6, heat resistant	SMEO-8E-...-230
Design	For T-slot	For T-slot	For T-slot
Conforms to standard	EN 60947-5-2	–	EN 60947-5-2
Certification	–	–	RCM trademark
CE marking (see declaration of conformity)	To EU EMC Directive ¹⁾ –	–	To EU EMC Directive ¹⁾ To EU Low Voltage Directive
Note on materials	Free of copper and PTFE RoHS-compliant	Free of copper and PTFE –	Free of copper and PTFE –

1) For information about the applicability of the component see the manufacturer's EC declaration of conformity at: www.festo.com/sp → Certificates.
If the component is subject to restrictions on usage in residential, office or commercial environments or small businesses, further measures to reduce the emitted interference may be necessary.

Input signal/measuring element			
	SMEO-8E-...-24	SMEO-8E-...-24-S6, heat resistant	SMEO-8E-...-230
Measuring principle	Magnetic reed	Magnetic reed	Magnetic reed
Ambient temperature [°C]	–40 ... +60	–40 ... +120	–20 ... +60

Switching output			
	SMEO-8E-...-24	SMEO-8E-...-24-S6, heat resistant	SMEO-8E-...-230
Switching output	Contacting, bipolar –	Contacting –	Contacting, bipolar Without LED function
Switching element function	N/O contact	N/O contact	N/O contact
Reproducibility of switching value [mm]	±0.1	±0.1	±0.1
Switch-on time [ms]	0 ... 0.5	0 ... 0.5	0 ... 2
Switch-off time [ms]	0.03	0.03	0.03
Max. switching frequency [Hz]	800	500	500
Max. output current [mA]	500	500	120
Max. switching capacity DC [W]	10	10	10
Max. switching capacity AC [VA]	10	10	10
Voltage drop [V]	–	0.5	3.9

Output, additional data	
Protection against short circuit	No
Overload protection	No

Electronic components			
	SMEO-8E-...-24	SMEO-8E-...-24-S6, heat resistant	SMEO-8E-...-230
Operating voltage range DC [V]	12 ... 30	0 ... 30	3 ... 250
Operating voltage range AC [V]	12 ... 30	0 ... 30	3 ... 230
Reverse polarity protection	No	For all electrical connections	No

Proximity sensors SMEO-8E, for T-slot

Technical data – Magnetic reed

Electromechanical components				
Type	SMEO-8E-S-LED-24	SMEO-8E-M12-LED-24	SMEO-8E-K-24-S6, heat resistant	SMEO-8E-M12-LED-230
Electrical connection	Plug M8x1, 3-pin	Plug M12x1, 3-pin	Cable, 2-wire	Plug M12x1, 3-pin
Connection direction	Lateral	Lateral	Lateral	In-line
Pin contact materials	Nickel-plated brass	Brass	–	–
Cable length [m]	–	–	2.5	–
Cable sheath materials	–	–	TPE-S	–

Mechanical components				
Type	SMEO-8E-S-LED-24	SMEO-8E-M12-LED-24	SMEO-8E-K-24-S6, heat resistant	SMEO-8E-M12-LED-230
Type of mounting	Via accessories		Via accessories	Via accessories
Tightening torque [Nm]	0.5	0.5	0.5	0.5
Housing material information	TPE-U(PU)	TPE-U(PU)	TPE-U(PU)	TPE-U(PU)
	High-alloy stainless steel	High-alloy stainless steel	–	High-alloy stainless steel
	Wrought aluminium alloy	Wrought aluminium alloy	–	Wrought aluminium alloy
	Nickel-plated brass	–	–	–

Display/operation			
	SMEO-8E-...-24	SMEO-8E-...-24-S6, heat resistant	SMEO-8E-...-230
Switching status indication	Yellow LED	–	Yellow LED

Immissions/emissions			
	SMEO-8E-...-24	SMEO-8E-...-24-S6, heat resistant	SMEO-8E-...-230
Ambient temperature with flexible cable installation [°C]	–	–40 ... +120	–
Degree of protection	IP65	IP65	IP65
	IP67	IP67	IP67
Insulation voltage [V]	–	50	–
Surge resistance [kV]	0.8	–	4
Degree of contamination	3	3	3

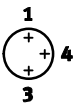
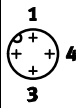
Pin allocation to EN 60947-5-2				
M8x1, 3-pin			M12x1, 3-pin, 24 V	
N/O contact			N/O contact	
	Pin	Wire colour	Allocation	
	1	Brown	+	
	3	Blue	–	
	4	Black	Output	

Pin allocation to EN 60947-5-2			
M12x1, 3-pin, 230 V			
N/O contact			
	Pin	Wire colour	Allocation
	4	Black	~ / +
	3	Blue	~ / –

Proximity sensors SMEO-8E, for T-slot

Technical data – Magnetic reed



Dimensions

Download CAD data → www.festo.com

SMEO-8E-S-LED-24 – Plug M8x1

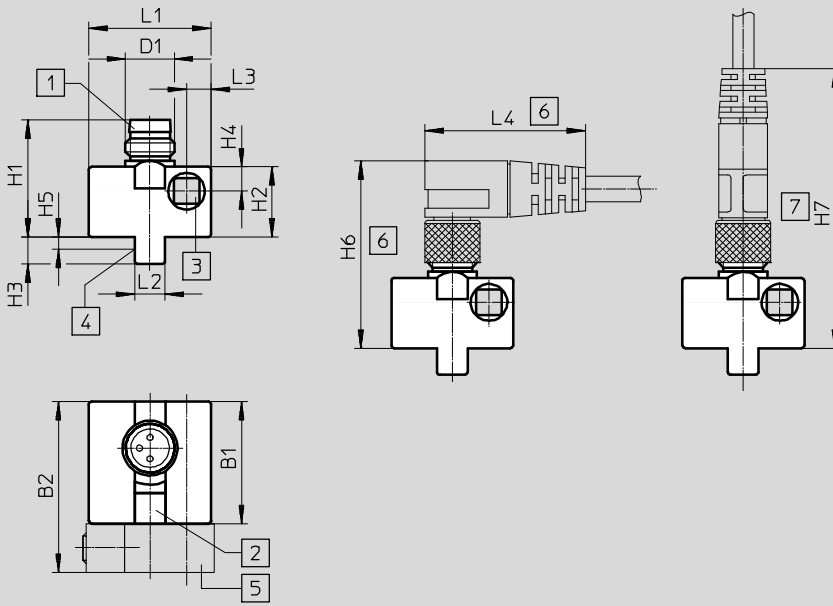

- 1 Suitable for socket type SIM-M8
- 2 Yellow LED
- 3 Socket head screw M3x25 DIN 912, max. tightening torque 1 Nm
- 4 Theoretical switching point
- 5 Mounting kit SMB-8E (not included in scope of delivery)
- 6 Installation space for angled plug socket 90°
- 7 Installation space for straight plug socket

	B1 ±0.3	B2	D1	H1	H2 ±0.27	H3	H4	H5	H6	H7	L1 ±0.3	L2	L3	L4
SMEO-8E- ... -S-LED-24	20	28	M8x1	19.2	11.5	4.4	4	2.2	~32	~46	20	5	4	~26

Dimensions

Download CAD data → www.festo.com

SMEO-8E-M12-LED-24 – Plug M12x1

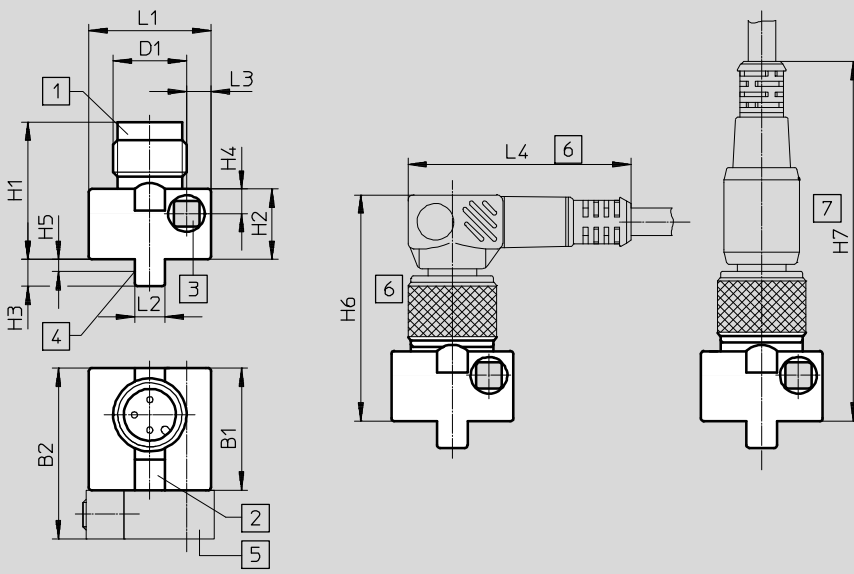

- 1 Suitable for socket type SIM-M12
- 2 Yellow LED
- 3 Socket head screw M3x25 DIN 912, max. tightening torque 1 Nm
- 4 Theoretical switching point
- 5 Mounting kit SMB-8E (not included in scope of delivery)
- 6 Installation space for angled plug socket 90°
- 7 Installation space for straight plug socket

	B1 ±0.3	B2	D1	H1 ±0.34	H2 ±0.27	H3	H4	H5	H6	H7	L1 ±0.3	L2	L3	L4
SMEO-8E- ... -M12-LED-24	20	28	M12x1	22.5	11.5	4.4	4	2.2	~36	~59	20	5	4	~36.5

Proximity sensors SMEO-8E, for T-slot

Technical data – Magnetic reed

Dimensions

Download CAD data → www.festo.com

SMEO-8E-K24-S6 – Cable, heat resistant to 120°C

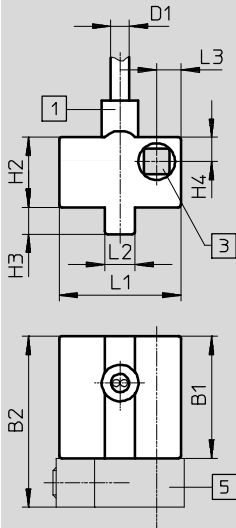

- 1 Cable, 2.5 m long, 2 x 0.14mm²
- 3 Socket head screw M3x25 DIN 912, max. tightening torque 1 Nm
- 5 Mounting kit SMB-8E (not included in scope of delivery)

	B1 ±0.3	B2	D1	H2 ±0.27	H3	H4	L1 ±0.3	L2	L3
SMEO-8E-K24-S6	20	28	2.9	11.5	4.4	4	20	5	4

Ordering data

	Switching output	Electrical connection			Cable length [m]	Product weight [g]	Part No.	Type
		Cable	Plug M8x1	Plug M12x1				
N/O contact, basic version								
	Contacting, bipolar	-	3-pin	-		10	171163	SMEO-8E-S-LED-24
			-	3-pin				
N/O contact, heat resistant								
	Contacting, bipolar		2-wire	-	2.5	40	171158	SMEO-8E-K-24-S6
N/O contact, operating voltage range 3 ... 250 V AC/DC								
	Contacting, bipolar		-	3-pin	-	9	171160	SMEO-8E-M12-LED-230

Proximity sensors SMT/SME-8, for T-slot

Accessories



Mounting kit SMBR-8-8/100-S6

Material:

Rail: Anodised wrought aluminium alloy

Clamping strap, screws: High-alloy stainless steel

Free of copper and PTFE

RoHS-compliant

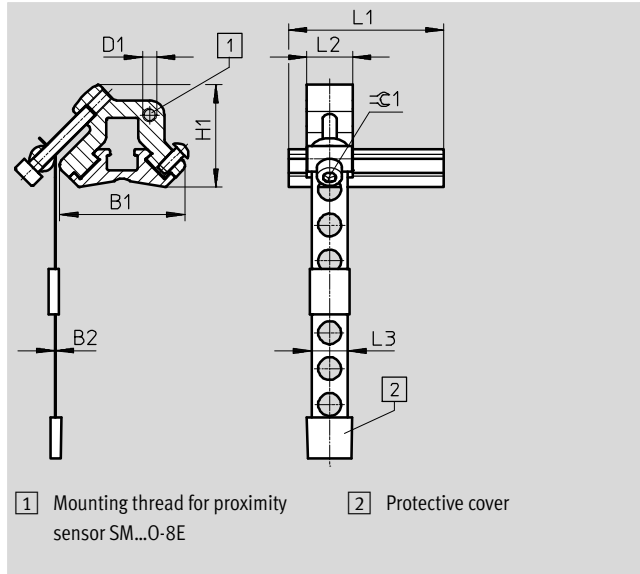

Dimensions and ordering data											
For piston Ø	B1	B2	D1	H1	L1	L2	L3	±0.1	CRC ¹⁾	Part No.	Type
8 ... 100	27.4	0.2	M3	22.4	34	10	7.9	2.5	4	★ 538937	SMBR-8-8/100-S6

1) Corrosion resistance class 4 to Festo standard 940 070
Components subject to high corrosion stress. Parts used with aggressive media, e.g. in the food or chemical industry. These applications should be supported with special tests with the media if required.

Mounting kit SMBR

Material:

Polyacetal

RoHS-compliant

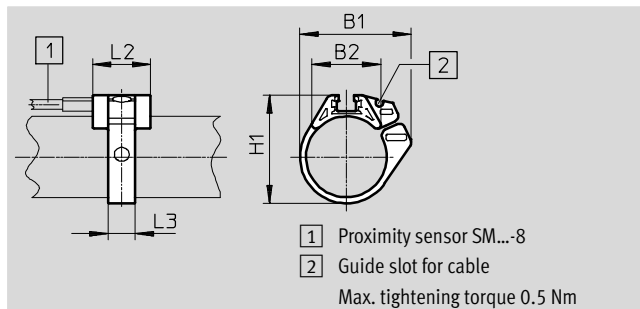

Dimensions and ordering data							
For piston Ø	B1	B2	H1	L2	L3	Part No.	Type
8	18.9	12.3	18.4	19	7	175091	SMBR-8-8
10	20.4	13.8	20.4	19	7	175092	SMBR-8-10
12	22.7	14.3	21.9	19	7	★ 175093	SMBR-8-12
16	28.2	16.9	25.7	19	8	★ 175094	SMBR-8-16
20	34.5	20.8	30.4	19	9	★ 175095	SMBR-8-20
25	36.7	22.7	35.6	19	9	★ 175096	SMBR-8-25
32	41.7	24.6	42.7	19	9	175097	SMBR-8-32
40	47.1	26.5	50.7	19	9	175098	SMBR-8-40
50	56.4	28.6	61.5	19	9	175099	SMBR-8-50
63	69.4	32	74.5	19	9	175100	SMBR-8-63

Festo core product range

★ Ready for dispatch from the Festo factory in 24 hours

☆ Ready for dispatch in 5 days maximum from stock

Proximity sensors SMT/SME-8, for T-slot

Accessories

Mounting kit CRSMB

Design: For round cylinders
 Type of mounting: Bonded using enclosed adhesive tape

Degree of protection: IP65, IP68, IP69K
 Ambient temperature: -40 ... +90 °C
 Material:
 Housing: Polyurethane
 Rail: Hard anodised aluminium
 Free of copper and PTFE

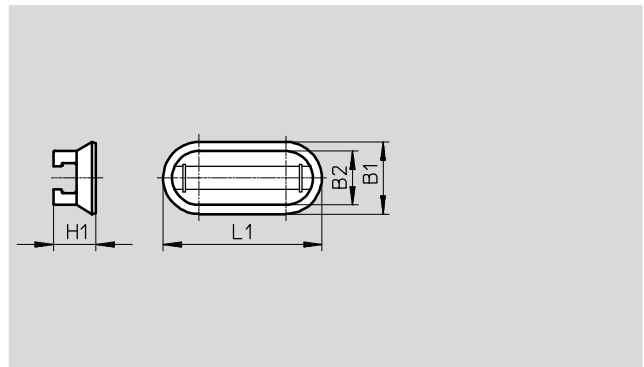

Ordering data							
For piston ∅	B1	B2	H1	L1	CRC ¹⁾	Part No.	Type
32 ... 100	15.8	11.8	9.3	35	4	525565	CRSMB-8-32/100

1) Corrosion resistance class 4 to Festo standard 940 070
 Components subject to high corrosion stress. Parts used with aggressive media, e.g. in the food or chemical industry. These applications should be supported with special tests with the media if required.

Mounting kit SMB-8-FENG

Material:
 Wrought aluminium alloy
 Free of copper and PTFE

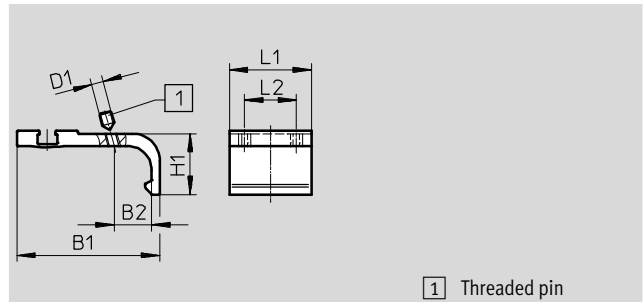
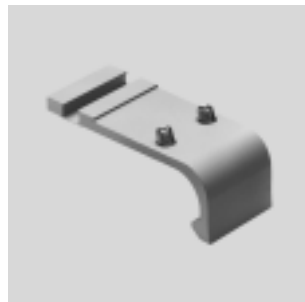

1 Threaded pin

Dimensions and ordering data									
For piston ∅	B1	B2	D1	H1	L1	L2	Tightening torque [Nm]	Part No.	Type
32/40	35.1	8.7	M3	15.5	27	17	0.2	175705	SMB-8-FENG-32/40
50/63	47	12.3	M4	20	27	17	0.5	175706	SMB-8-FENG-50/63
80/100	64.3	15.7	M5	24.3	27	17	0.7	175707	SMB-8-FENG-80/100

Mounting kit SMB-8E

Material:
 Anodised aluminium, stainless steel

Note on materials:
 RoHS-compliant

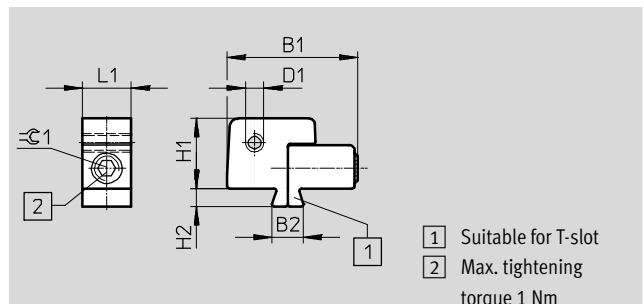

1 Suitable for T-slot
 2 Max. tightening torque 1 Nm

Ordering data									
For piston ∅	B1	B2	D1	H1	H2	L1	≈C1	Part No.	Type
10 ... 125	21.5	5.1	M3	11.5	3	8	2.5	178230	SMB-8E

Proximity sensors SMT/SME-8, for T-slot

Accessories

Mounting kit SMB-8-C

Temperature: -40 ... 120°C
 Material:
 Retainer: Anodised wrought aluminium alloy
 Screws: High-alloy stainless steel
 Free of copper and PTFE,
 RoHS-compliant

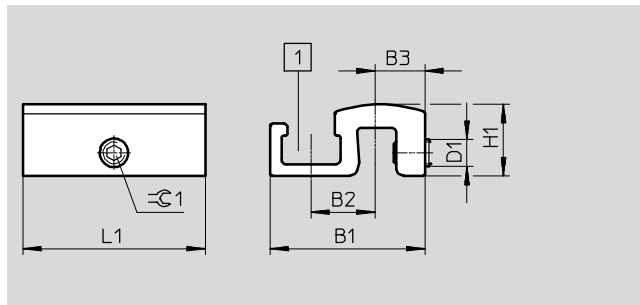

Dimensions and ordering data												
Type	B1	B2	B3	D1	H1	L1	rC1	Tightening torque [Nm]	CRC ¹⁾	Weight [g]	Part No.	Type
SMB-8-C	17	7	5.5	M3	7.8	20	1.5	0.2 ... 0.6	3	3.5	1806790	SMB-8-C

1) Corrosion resistance class 3 according to Festo standard 940 070
 Components subject to high corrosion stress. Externally visible parts with primarily functional surface requirements which are in direct contact with a normal industrial environment or media such as solvents and cleaning agents.

Sensor bracket DASP-M4-...-A

Material:
 Anodised wrought aluminium alloy
 Screws: High-alloy stainless steel
 RoHS-compliant

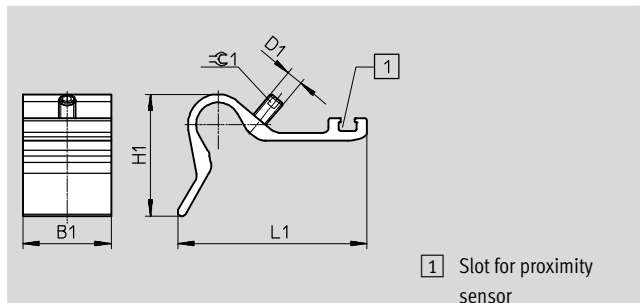

Dimensions and ordering data										
Type	B1	D1	H1	L1	rC1	Tightening torque [Nm]	CRC ¹⁾	Weight [g]	Part No.	Type
DASP-M4-125-A	32.5	M5	28	45.4	2.5	1	3	26.5	1451483	DASP-M4-125-A
DASP-M4-160-A	32.5	M6	44.7	69.4	3	1	3	41.5	1553813	DASP-M4-160-A
DASP-M4-250-A	32.5	M6	56.3	88	3	1	3	60	1456781	DASP-M4-250-A
DASP-M4-320-A	32.5	M6	56.3	88	3	1	3	60	3015256	DASP-M4-320-A

1) Corrosion resistance class 3 according to Festo standard 940 070
 Components subject to high corrosion stress. Externally visible parts with primarily functional surface requirements which are in direct contact with a normal industrial environment or media such as solvents and cleaning agents.

Proximity sensors SMT/SME-8, for T-slot

Accessories

Mounting SMBZ-8-...

Material:

Rail: Anodised wrought aluminium alloy

Screws: high-alloy stainless steel

Free of copper and PTFE

RoHS-compliant

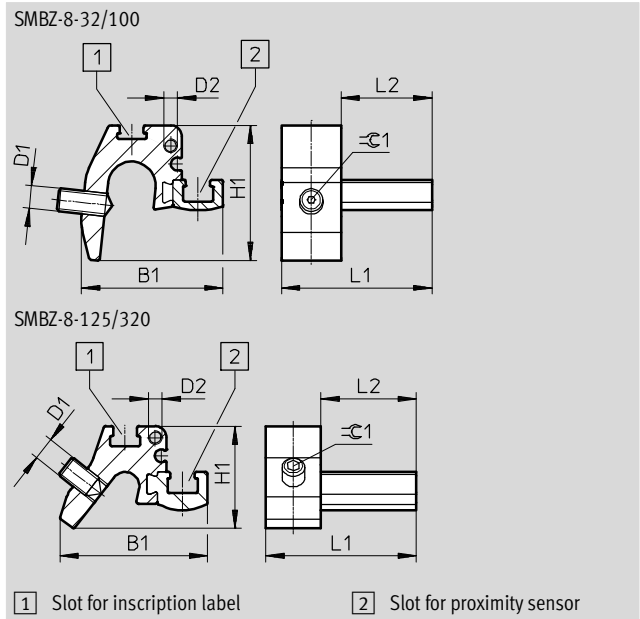

Dimensions and ordering data								
For piston \varnothing	B1	D1	D2	H1	L1	L2	$\approx C1$	Part No. Type
32 ... 100	31	M5	M3	30	33	20	1.5	537806 SMBZ-8-32/100
125 ... 320	32.3			22			2.5	537808 SMBZ-8-125/320

Position marker SMM

Insertable in the slot lengthwise

Ambient temperature $-40 \dots +120 \text{ }^\circ\text{C}$

Material:

Housing: anodised wrought aluminium alloy

Screws: High-alloy stainless steel

Note on materials: RoHS-compliant

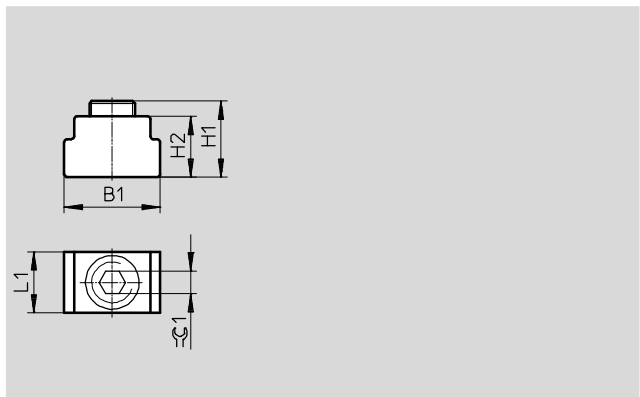

Dimensions and ordering data							
B1	H1	H2	L1	$\approx C1$	CRC ¹⁾	Part No. Type	PU ²⁾
6.3	5.0	4.0	4.0	1.5	3	547941 SMM-8	10

1) Corrosion resistance class 3 according to Festo standard 940 070







Components subject to high corrosion stress. Externally visible parts with primarily functional surface requirements which are in direct contact with a normal industrial environment or media such as solvents and cleaning agents.

2) Packaging unit

Proximity sensors SMT/SME-8, for T-slot

Accessories

FESTO

Ordering data – Connecting cables				Technical data → Internet: nebu, sim	
		Number of wires	Cable length [m]	Part No.	Type
Socket M8x1, 3-pin					
	For SMT/SME-8... and SMT0/SMTSO/SME0-8E	3	2.5	★ 541333	NEBU-M8G3-K-2.5-LE3
			5	★ 541334	NEBU-M8G3-K-5-LE3
	For SMT/SME-8... and SMT0/SMTSO/SME0-8E	3	2.5	★ 541338	NEBU-M8W3-K-2.5-LE3
			5	★ 541341	NEBU-M8W3-K-5-LE3
Socket M12x1, 5-pin					
	For SMT/SME-8M and SMT0/SMTSO/SME0-8E	3	2.5	★ 541363	NEBU-M12G5-K-2.5-LE3
			5	★ 541364	NEBU-M12G5-K-5-LE3
	For SMT/SME-8M and SMT0/SMTSO/SME0-8E	3	2.5	541367	NEBU-M12W5-K-2.5-LE3
			5	541370	NEBU-M12W5-K-5-LE3
Socket M12x1, resistant to welding spatter					
	For SDBT and SMTSO	3	3	30450	SIM-M12-RS-3GD-3
	For SDBT and SMTSO	3	3	30451	SIM-M12-RS-3WD-3

Ordering data – Safety clips for ATEX zone					
	Size	Description	Part No.	Type	PU ¹⁾
	M8	<ul style="list-style-type: none"> Protects "equipment that is not intrinsically safe" in zones 2 and 22 against simple disconnection ATEX category: gas: II 3G / dust: II 3D 	548067	NEAU-M8-GD	1
	M12		548068	NEAU-M12-GD	1

1) Packaging unit

Ordering data – Mounting components			
	Description	Part No.	Type
	For locating connecting cables	534254	SMBK-8

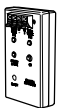
Ordering data – Sensor tester			
	Description	Part No.	Type
	<ul style="list-style-type: none"> Testing operation of proximity sensors using the integrated voltage supply Adjustment of proximity sensors on the cylinder 	158481	SM-TEST-1

Ordering data – Inscription labels				
	Size	Part No.	Type	PU ¹⁾
	23x4 mm	541598	ASLR-L-423	34

1) Packaging unit

Festo core product range

- ★ Ready for dispatch from the Festo factory in 24 hours
- ☆ Ready for dispatch in 5 days maximum from stock