



Control relay, 24 V DC, 8DI(2AI), 4DO-Trans, time

Part no. **EASY512-DC-TCX**
 Article no. **274112**

Delivery program

Product range			Control relays easyRelay
Basic function			easy500
Description			Stand alone customized laser inscription or delivery with user program possible with EASY-COMBINATION-* product (article No. 2010781)
Inputs			
Digital input count			digital: 8 digital: 8; of which can be used as analog: 2
Digital			8
of which can be used as analog			2
Outputs			
Type			Transistor
Quantity of outputs			Transistor: 4
Outputs		Number	4
Transistor			4
Additional features			
Display			without display, without keypad
Real time clock			✓
Supply voltage			24 V DC
Software			EASY-SOFT-BASIC/-PRO

Technical data

General

Standards			EN 55011, EN 55022, IEC/EN 61000-4, IEC 60068-2-6, IEC 60068-2-27
Dimensions (W x H x D)		mm	71.5 x 90 x 58 (4 PE)
Weight		kg	0.2
Mounting			Top-hat rail IEC/EN 60715, 35 mm or screw fixing using fixing brackets ZB4-101-GF1 (accessories)

Terminal capacities

Solid		mm ²	0.2/4 (AWG 22 - 12)
Flexible with ferrule		mm ²	0.2/2.5 (AWG 22 - 12)
Standard screwdriver		mm	3.5 x 0.8
Max. tightening torque		Nm	0.6

Climatic environmental conditions

Operating ambient temperature		°C	In accordance with IEC 60068-2-1, -25 - +55
Condensation			Take appropriate measures to prevent condensation
Storage	θ	°C	-40 - +70
relative humidity		%	in accordance with IEC 60068-2-30, IEC 60068-2-78 5 - 95
Air pressure (operation)		hPa	795 - 1080

Ambient conditions, mechanical

Protection type (IEC/EN 60529, EN50178, VBG 4)			IP20
Vibrations	3,5 mm / 1 g	Hz	In accordance with IEC 60068-2-6 constant amplitude 0.15 mm: 10 - 57 constant acceleration 2 g: 57 - 150
Mechanical shock resistance (IEC/EN 60068-2-27) semi-sinusoidal 15 g/11 ms		Impacts	18
Drop to IEC/EN 60068-2-31	Drop height	mm	50
Free fall, packaged (IEC/EN 60068-2-32)		m	1
Mounting position			Vertical or horizontal

Electromagnetic compatibility (EMC)

Overvoltage category/pollution degree			III/2
---------------------------------------	--	--	-------

Electrostatic discharge (ESD)			
applied standard			according to IEC EN 61000-4-2
Air discharge		kV	8
Contact discharge		kV	6
Electromagnetic fields (RFI) to IEC EN 61000-4-3		V/m	10
Radio interference suppression			EN 55011 Class B, EN 55022 Class B
Burst		kV	according to IEC/EN 61000-4-4 Supply cables: 2 Signal cables: 2
power pulses (Surge)			according to IEC/EN 61000-4-5 1 kV (supply cables, symmetrical)
Immunity to line-conducted interference to (IEC/EN 61000-4-6)		V	10

Insulation resistance

Clearance in air and creepage distances			EN 50178, UL 508, CSA C22.2, No. 142
Insulation resistance			EN 50178

Back-up of real-time clock

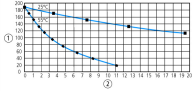
Back-up of real-time clock			 <p>① Backup time (hours) with fully charged double layer capacitor ② Service life (years)</p>
Accuracy of real-time clock to inputs		s/day	typ. ± 2 (± 0.2 h/Year) depending on ambient air temperature fluctuations of up to ± 5 s/day (± 0.5 h/year) are possible

Repetition accuracy of timing relays

Accuracy of timing relays (of values)		%	± 1
Resolution			
Range "S"		ms	10
Range "M:S"		s	1
Range "H:M"		min	1

Retentive memory



Write cycles of the retentive memory			1000000 (10^6)
--------------------------------------	--	--	--------------------

Power supply

Rated operational voltage	U_e	V	24 DC (-15/+20%)
Permissible range	U_e		20.4 - 28.8 V DC
Residual ripple		%	≤ 5
Siemens MPI, (optional)			yes (Notice: A short-circuit will result if 0 V or earth is applied to the outputs in the event that the supply voltage is connected to the wrong poles.)
Input current			normally 80 mA at U_e
Voltage dips		ms	\leq In accordance with IEC 61131-2 ≤ 10
Fuse		A	≤ 1 A (T)
Power loss	P	W	Normally 2

Digital inputs 24 V DC



Number			8
Inputs can be used as analog inputs			2 (I7,I8)
Potential isolation			from power supply: no between digital inputs: no from the outputs: yes to interface/memory card: no
Rated operational voltage	U_e	V DC	24
Input voltage		V DC	Signal 0: ≤ 5 (I1 - I8) Signal 1: ≤ 15 (I1 - I6), ≤ 8 (I7, I8)
Input current at signal 1		mA	I1 - I6: 3.3 (at 24 V DC) I7, I8: 2.2 (at 24 V DC)
Deceleration time		ms	20 (0 -> 1/1 -> 0, Debounce ON) normally 0.25 (0 -> 1, Debounce OFF, I1 - I8)
Cable length		m	100 (unshielded)
Frequency counter			

Number			2 (I3, I4)
Counter frequency		kHz	 1
Pulse shape			Square
Pulse pause ratio			1:1
Cable length		m	 20 (screened)
Rapid counter inputs			
Number			2 (I1, I2)
Cable length		m	 20 (screened)
Counter frequency		kHz	< 1
Pulse shape			Square
Pulse pause ratio			1:1

Analog inputs

Number			2 (I7, I8)
Potential isolation			from power supply: no between digital inputs: no from the outputs: yes to interface/memory card: no
Input type			DC voltage
Signal range			0-10 V DC
Resolution			0.01 V analog 0.01 V digital 10 Bit (value 0 - 1023)
Input impedance		kΩ	11.2
Accuracy of actual value			
Two EASY devices		%	± 3
Within a single device		%	± 2, (I7, I8, I11, I12) ± 0.12 V
Conversion time, analog/digital		ms	Input delay ON: 20; Input delay OFF: each cycle time
Input current		mA	< 1
Cable length		m	 30, screened

Transistor outputs

Number			4
Rated operational voltage	U_e	V DC	24
Permissible range	U_e		20.4 - 28.8 V DC
Residual ripple		%	5
Supply current		mA	Norm./max. 9/16 at signal 0 12/22 at signal 1
Siemens MPI, (optional)			yes (Notice: A short-circuit will result if 0 V or earth is applied to the outputs in the event that the supply voltage is connected to the wrong poles.)
Potential isolation			from power supply: yes From the inputs: yes to the interface: yes to the memory card: yes
Rated operational current at signal „1“ DC per channel	I_e	A	Max. 0.5
Residual current on 0 signal per channel		mA	< 0.1
Max. output voltage		V	2.5 (signal 0 at external load < 10 MΩ) $U = U_e - 1 \text{ V}$ (signal 1 at $I_e = 0.5 \text{ A}$)
Short-circuit protection			Yes, thermal (analysis via diagnostics input I16, I15; R15, R16)
Short-circuit tripping current for R_a  10 mΩ		A	$0.7 \cdot I_e$  2 per output
Total short-circuit current		A	8
Peak short-circuit current		A	16
Thermal cutout			Yes
Max. operating frequency with constant resistive load		Operations/h	40000
Parallel connection of outputs			
With resistive load, inductive load with external suppressor circuit, combination within a group			Group 1: Q1 to Q4
Number of outputs	max.		4
Max. total current		A	2 (Caution! Outputs must be actuated simultaneously and for the same length of time.)

Output status indication			LCD-display
Inductive load to EN 60947-5-1			
Without external suppressor circuit			
$T_{0.95} = 1 \text{ ms}$, $R = 48 \Omega$, $L = 16 \text{ mH}$			
Utilization factor	g		0.25
Duty factor	% DF		100
Max. switching frequency $f = 0.5 \text{ Hz}$ (max. DF = 50 %)		Operation	500
DC-13, $T_{0.95} = 72 \text{ ms}$, $R = 48 \Omega$, $L = 1.15 \text{ H}$			
Utilization factor	g		0.25
Duty factor	% DF		100
Max. switching frequency $f = 0.5 \text{ Hz}$ (max. DF = 50 %)		Operation	500
$T_{0.95} = 15 \text{ ms}$, $R = 48 \Omega$, $L = 0.24 \text{ H}$			
Utilization factor	g		0.25
Duty factor	% DF		100
Max. switching frequency $f = 0.5 \text{ Hz}$ (max. DF = 50 %)		Operation	500
With external suppressor circuit			
Utilization factor	g		1
Duty factor	% DF		100
Max. switching frequency, max. duty factor		Operation	Depending on the suppressor circuit

Supply voltage U_{Aux}

Siemens MPI, (optional)			yes (Notice: A short-circuit will result if 0 V or earth is applied to the outputs in the event that the supply voltage is connected to the wrong poles.)
Power loss	P	W	2

Design verification as per IEC/EN 61439

Technical data for design verification			
Rated operational current for specified heat dissipation	I_n	A	0
Heat dissipation per pole, current-dependent	P_{vid}	W	0
Equipment heat dissipation, current-dependent	P_{vid}	W	0
Static heat dissipation, non-current-dependent	P_{vs}	W	2
Heat dissipation capacity	P_{diss}	W	0
Operating ambient temperature min.		°C	-25
Operating ambient temperature max.		°C	55
IEC/EN 61439 design verification			
10.2 Strength of materials and parts			
10.2.2 Corrosion resistance			Meets the product standard's requirements.
10.2.3.1 Verification of thermal stability of enclosures			Meets the product standard's requirements.
10.2.3.2 Verification of resistance of insulating materials to normal heat			Meets the product standard's requirements.
10.2.3.3 Verification of resistance of insulating materials to abnormal heat and fire due to internal electric effects			Meets the product standard's requirements.
10.2.4 Resistance to ultra-violet (UV) radiation			Meets the product standard's requirements.
10.2.5 Lifting			Does not apply, since the entire switchgear needs to be evaluated.
10.2.6 Mechanical impact			Does not apply, since the entire switchgear needs to be evaluated.
10.2.7 Inscriptions			Meets the product standard's requirements.
10.3 Degree of protection of ASSEMBLIES			Meets the product standard's requirements.
10.4 Clearances and creepage distances			Meets the product standard's requirements.
10.5 Protection against electric shock			Does not apply, since the entire switchgear needs to be evaluated.
10.6 Incorporation of switching devices and components			Does not apply, since the entire switchgear needs to be evaluated.
10.7 Internal electrical circuits and connections			Is the panel builder's responsibility.
10.8 Connections for external conductors			Is the panel builder's responsibility.
10.9 Insulation properties			
10.9.2 Power-frequency electric strength			Is the panel builder's responsibility.
10.9.3 Impulse withstand voltage			Is the panel builder's responsibility.
10.9.4 Testing of enclosures made of insulating material			Is the panel builder's responsibility.
10.10 Temperature rise			The panel builder is responsible for the temperature rise calculation. Eaton will provide heat dissipation data for the devices.

10.11 Short-circuit rating		Is the panel builder's responsibility.
10.12 Electromagnetic compatibility		Is the panel builder's responsibility.
10.13 Mechanical function		The device meets the requirements, provided the information in the instruction leaflet (IL) is observed.

Technical data ETIM 6.0

PLC's (EG000024) / Logic module (EC001417)		
Electric engineering, automation, process control engineering / Control / Programmable logic control (SPS) / Logic module (ecl@ss8.1-27-24-22-16 [AKE539011])		
Supply voltage AC 50 Hz	V	0 - 0
Supply voltage AC 60 Hz	V	0 - 0
Supply voltage DC	V	20.4 - 28.8
Voltage type of supply voltage		DC
Switching current	A	0.5
Number of analogue inputs		2
Number of analogue outputs		0
Number of digital inputs		8
Number of digital outputs		4
With relay output		No
Number of HW-interfaces industrial Ethernet		0
Number of HW-interfaces PROFINET		0
Number of HW-interfaces RS-232		0
Number of HW-interfaces RS-422		0
Number of HW-interfaces RS-485		0
Number of HW-interfaces serial TTY		0
Number of HW-interfaces USB		0
Number of HW-interfaces parallel		0
Number of HW-interfaces Wireless		0
Number of HW-interfaces other		1
With optical interface		No
Supporting protocol for TCP/IP		No
Supporting protocol for PROFIBUS		No
Supporting protocol for CAN		No
Supporting protocol for INTERBUS		No
Supporting protocol for ASI		No
Supporting protocol for KNX		No
Supporting protocol for MODBUS		No
Supporting protocol for Data-Highway		No
Supporting protocol for DeviceNet		No
Supporting protocol for SUCONET		No
Supporting protocol for LON		No
Supporting protocol for PROFINET IO		No
Supporting protocol for PROFINET CBA		No
Supporting protocol for SERCOS		No
Supporting protocol for Foundation Fieldbus		No
Supporting protocol for EtherNet/IP		No
Supporting protocol for AS-Interface Safety at Work		No
Supporting protocol for DeviceNet Safety		No
Supporting protocol for INTERBUS-Safety		No
Supporting protocol for PROFIsafe		No
Supporting protocol for SafetyBUS p		No
Supporting protocol for other bus systems		No
Radio standard Bluetooth		No
Radio standard WLAN 802.11		No
Radio standard GPRS		No
Radio standard GSM		No
Radio standard UMTS		No

IO link master			No
Redundancy			No
With display			No
Degree of protection (IP)			IP20
Basic device			Yes
Expandable			No
Expansion device			No
With timer			Yes
Rail mounting possible			Yes
Wall mounting/direct mounting			Yes
Front build in possible			No
Rack-assembly possible			No
Suitable for safety functions			No
Category according to EN 954-1			
SIL according to IEC 61508			None
Performance level acc. to EN ISO 13849-1			None
Appendant operation agent (Ex ia)			No
Appendant operation agent (Ex ib)			No
Explosion safety category for gas			None
Explosion safety category for dust			None
Width		mm	71.5
Height		mm	90
Depth		mm	58

Approvals

Product Standards			IEC/EN see Technical Data; UL 508; CSA C22.2 No. 142-M1987; CSA C22.2 No. 213-M1987; CE marking
UL File No.			E135462
UL Category Control No.			NRAQ
CSA File No.			012528
CSA Class No.			2252-01 + 2258-02
North America Certification			UL listed, CSA certified
Degree of Protection			IEC: IP20, UL/CSA Type: -

Dimensions

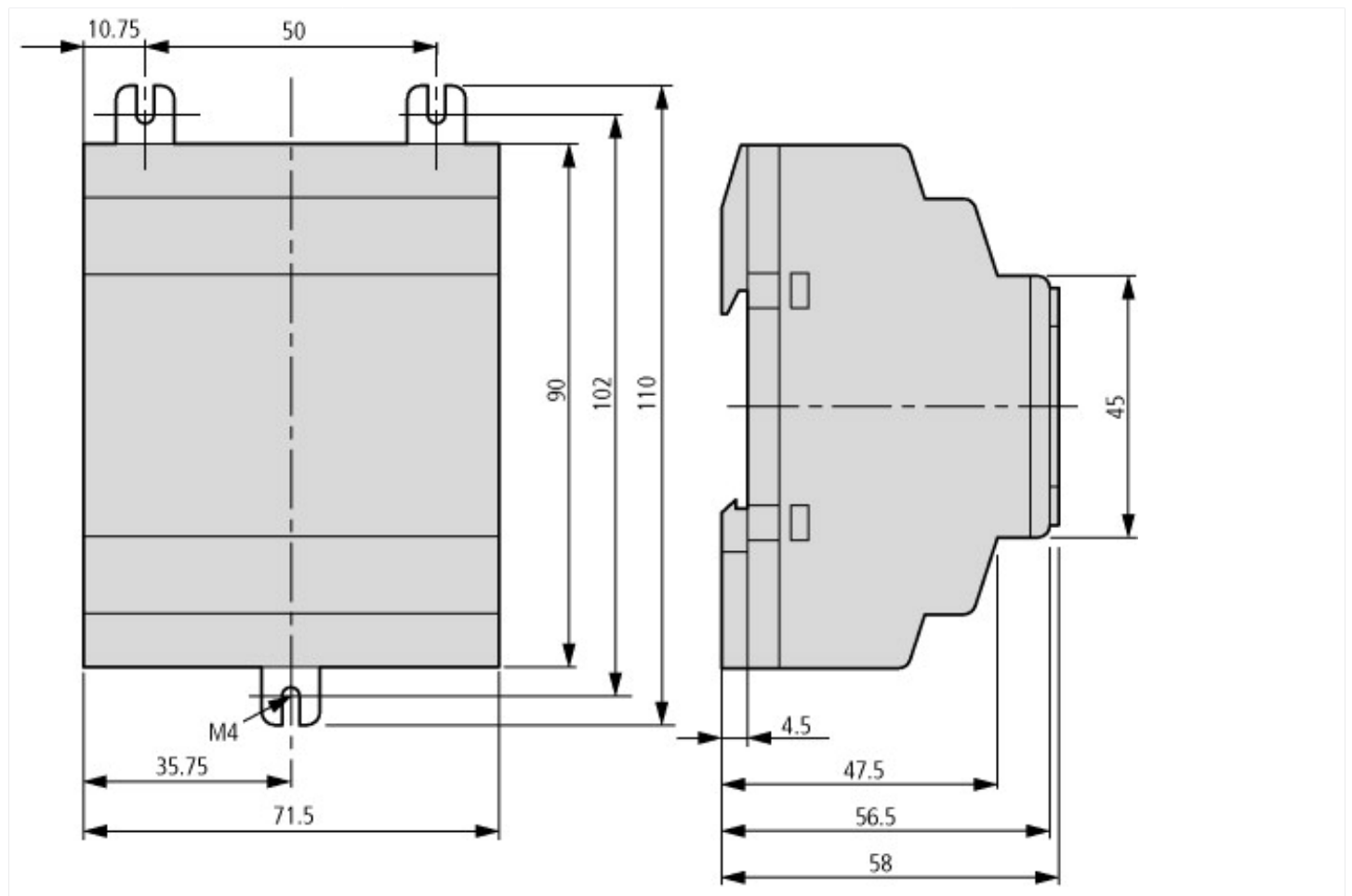

Additional product information (links)

Instruction leaflet "easy control relays" IL05013015Z (AWA2528-2105)

Instruction leaflet "easy control relays" IL05013015Z (AWA2528-2105) ftp://ftp.moeller.net/DOCUMENTATION/AWA_INSTRUCTIONS/IL05013015Z.pdf

Instruction leaflet "easy control relays" IL05013015Z (AWA2528-2105) ftp://ftp.moeller.net/DOCUMENTATION/AWA_INSTRUCTIONS/IL05013015Z2016_04.pdf

Manual "easy500, easy700 control relays" MN05013003Z (AWB2528-1508)

MN05013003Z (AWB2528-1508) Steuerrelais easy500, easy700 - Deutsch ftp://ftp.moeller.net/DOCUMENTATION/AWB_MANUALS/MN05013003Z_DE.pdf

MN05013003Z (AWB2528-1508) easy500, easy700 control relay - English ftp://ftp.moeller.net/DOCUMENTATION/AWB_MANUALS/MN05013003Z_EN.pdf

Labeleditor (Beschriftungssoftware) <http://downloadcenter.moeller.net/de/software.f6023a63-5acb-42c7-a51c-ccf99091cace>