

# AE1/AN-4A

cylindrical inductive



Micro Detectors

Italian Sensors Technology



Indicative image

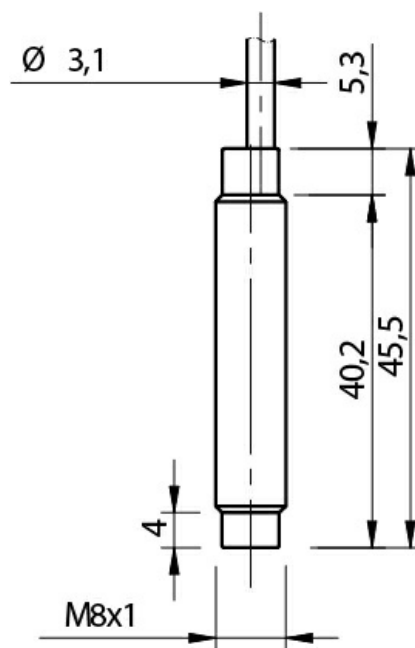

## Detection properties

Nominal sensing distance	4mm
Operanting distance	0...3,24mm
Standard target	12x12mm FE360
Correction Factor	copper: 0,47 / aluminium: 0,52 / brass: 0,58 / stainless steel: 0,79
Thermal drift of Sr	< 10%
Repeat Accuracy	5% (UB 24V Ta=23°C ±5°C)
Hysteresis	1 ... 20%

## Outputs

Output type	NPN
Output Function	NO
Switching frequency	5kHz

## Electrical data

Operating Voltage	10...30Vdc
No-Load supply current	≤ 10mA
Load current	≤ 200mA
Leakage current	≤ 10μA
Output voltage drop	≤ 1,8V @200mA
Max ripple content	≤10%
LED indicators	Yellow LED output state
Time delay before availability	≤ 50ms
Short-circuit protection	Yes
Reverse Polarity Protection	Yes
Protection against inductive loads	Yes

## Mechanical data

Mounting	Unshielded
Dimensions	M8 x 1 / L = 45,5mm
Weight	45g
Housing Material	Nickel-plated brass
Connections	2m PVC Cable
Active Head Material	PBT
Tightening torque	3Nm
Operating temperature	-25°C...+70°C
Diameter/Dimension	M8

## Test/Approvals

Approvals	CE UR
EMC compatibility	IEC 60947-5-2
Shocks and vibrations	Vibration IEC 60068-2-6 / Shock IEC 60068-2-27
Degree of protection	IP67

## Accessories

Supplied Accessories	2 nuts M8x1
----------------------	-------------

---

# ELECTRICAL DIAGRAMS OF THE CONNECTIONS

---

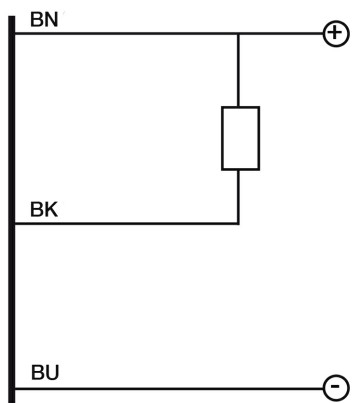

## INSTALLATION

---

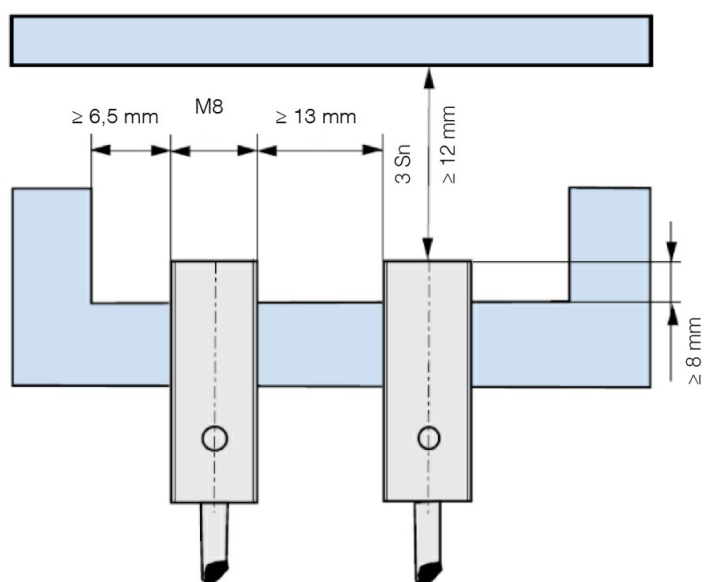

## RESPONSE CURVES

---

Disassamento Parallelo

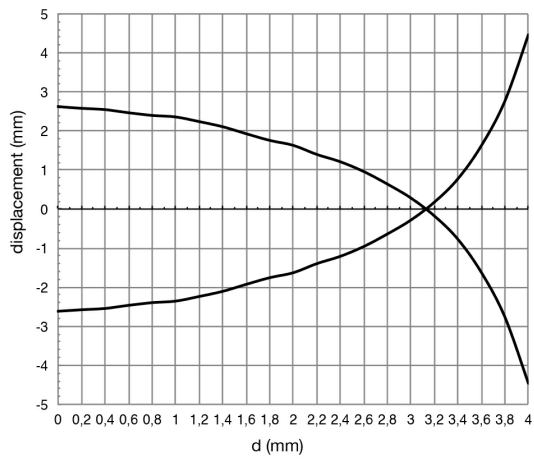

**M.D.Micro Detectors S.p.A.**

Strada S.Caterina, 235

41122 Modena (MO)

Tel. 059 420411

Fax 059 253973

E-mail [info@microdetectors.com](mailto:info@microdetectors.com)

**date of printing**

10/11/2020 12:06:37