

AM1/AP-4A

cylindrical inductive



Micro Detectors

Italian Sensors Technology



Indicative image

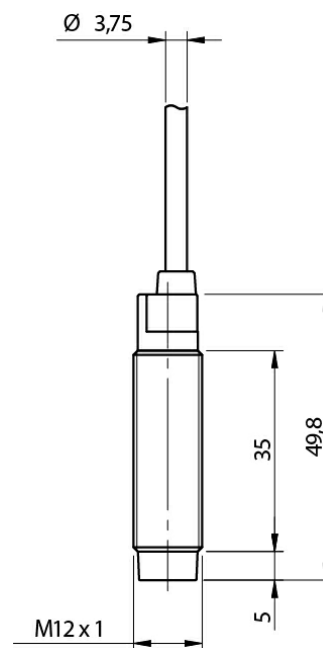

Detection properties

Nominal sensing distance	8mm
Operanting distance	0...6,4mm
Standard target	24x24mm FE360
Correction Factor	copper: 0,41 / aluminium: 0,46 / brass: 0,52 / stainless steel: 0,71
Thermal drift of Sr	< 10%
Repeat Accuracy	5% (UB 24V Ta=23°C ±5°C)
Hysteresis	1 ... 20%

Outputs

Output type	PNP
Output Function	NO
Switching frequency	2kHz

Electrical data

Operating Voltage	10...30Vdc
No-Load supply current	≤ 10mA
Load current	≤ 200mA
Leakage current	≤ 10μA
Output voltage drop	≤ 1,8V @200mA
Max ripple content	≤10%
LED indicators	Yellow LED output state
Time delay before availability	≤ 50ms
Short-circuit protection	Yes (auto-reset)
Reverse Polarity Protection	Yes
Protection against inductive loads	Yes

Mechanical data

Mounting	Unshielded
Dimensions	M12 x 1 / L= 49,8mm
Weight	70g
Housing Material	Nickel-plated brass
Connections	2m PVC Cable
Active Head Material	PBT
Tightening torque	10Nm
Operating temperature	-25°C...+70°C
Diameter/Dimension	M12

Test/Approvals

Approvals	CE UR
EMC compatibility	IEC 60947-5-2
Shocks and vibrations	Vibration IEC 60068-2-6 / Shock IEC 60068-2-27
Degree of protection	IP67

Accessories

Supplied Accessories	2 nuts M12x1
----------------------	--------------

ELECTRICAL DIAGRAMS OF THE CONNECTIONS

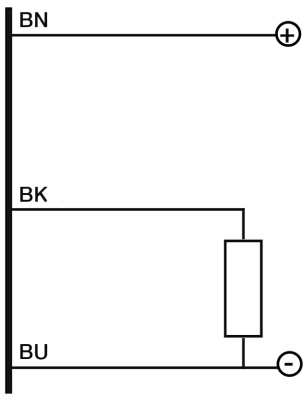

INSTALLATION

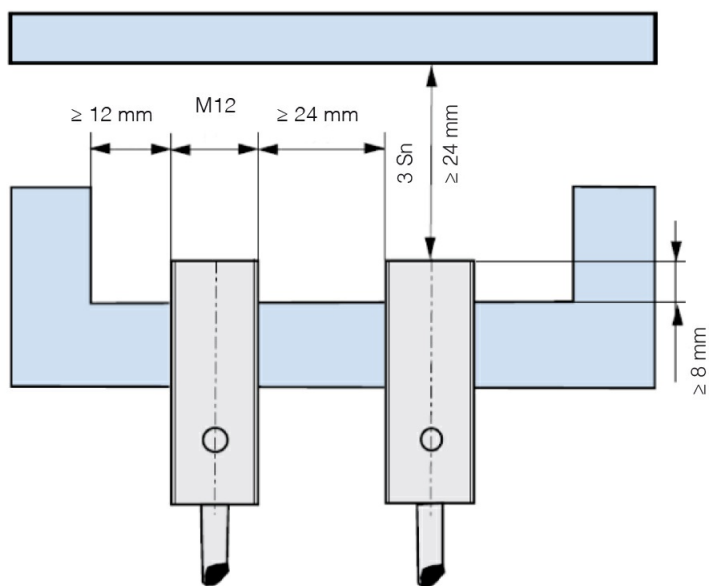

RESPONSE CURVES

Disassamento Parallelo

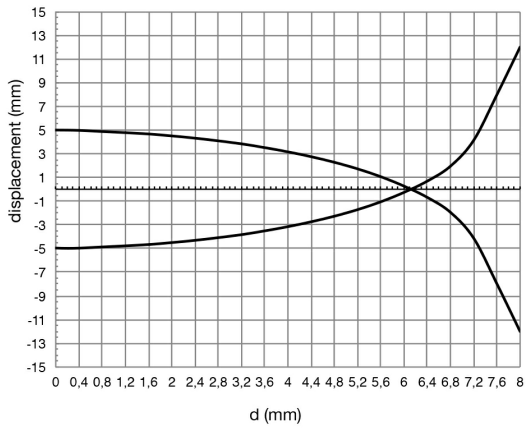

M.D. Micro Detectors S.p.A.

Strada S. Caterina, 235

41122 Modena (MO)

Tel. 059 420411

Fax 059 253973

E-mail info@microdetectors.com

date of printing

16/06/2020 09:45:20